

Partner
for your workshop

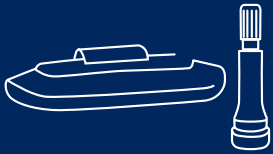

BALANCING WEIGHTS
AND VALVES

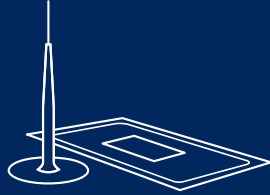

CONSUMABLES



CHEMICAL PRODUCTS

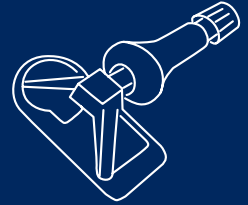

TPMS



TOOLS

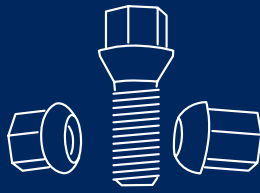

BOLTS AND NUTS



LIFTS



TYRE CHANGERS



WHEEL BALANCERS



AC MACHINES



DIAGNOSTICS AND
WHEEL ALIGNMENT

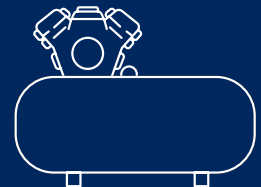

AIR COMPRESSORS

2022 / 2023

CONSUMABLES AND WORKSHOP EQUIPMENT

INVENTO

QUALITY AND INVENTION

**BALANCING WEIGHTS
AND VALVES**



CONSUMABLES



TOOLS



LIFTS



TYRE CHANGERS



WHEEL BALANCERS





AC MACHINE



WHEEL ALIGNMENTS















Meaning of symbols

	Bicycles
	Scooters
	Motorcycles
	Passenger vehicles
	Delivery cars
	Trucks
	Buses
	Agricultural vehicles
	Forklifts
	Construction equipment
	Air supply
	Supply 230V
	Supply 400V

Consumables

	page
KNOCK-ON WEIGHTS	5
MOTORCYCLE WEIGHTS	11
ADHESIVE WEIGHTS	12
ADHESIVE WEIGHTS/TYRE BALANCING POWDER	16
WHEEL WEIGHT ACCESSORIES	17
TYRE VALVES	18
TPMS SYSTEMS	34
TYRE MOUNTING PASTE	40
BRUSHES, TALCUM	41
CHEMICAL PRODUCTS	42
TYRE BAGS, CHALKS	43
HAND CLEANERS, CANS AND BRUSHES	44
TOOLS FOR TYRE REPAIR	45
PNEUMATIC	54
WORKSHOP TYRE INFLATORS	60
WHEEL BOLTS AND NUTS	61
TORQUE WRENCHES	69
POWER TOOLS	70
IMPACT SOCKETS	73
HAND TOOLS	76

Meaning of symbols

	Bicycles
	Scooters
	Motorcycles
	Passenger vehicles
	Delivery cars
	Trucks
	Buses
	Agricultural vehicles
	Forklifts
	Construction equipment
	Air supply
	Supply 230V
	Supply 400V

Workshop Equipment

	page
LIFTS	80
TYRE CHANGERS	90
WHEEL BALANCERS	100
AIR CONDITIONING	105
A/C ACCESSORIES	106
WHEEL ALIGNMENT	115
DIAGNOSTICS	118
ALLOY WHEEL STRAIGHTENER	120
AIR COMPRESSORS	121
AIR COMPRESSORS ACCESSORIES	123
THERMOPRESS MACHINES	124
TYRE SPREADERS	127
EQUIPMENT FOR TYRE HANDLING/SERVICE	128

Lead knock-on weights for steel rims



👁️	Weight	Material	Rim	Coating	Quantity	Index
1	5 g	lead	steel	uncoated	100 pcs.	TPSTD-005
2	10 g	lead	steel	uncoated	100 pcs.	TPSTD-010
3	15 g	lead	steel	uncoated	100 pcs.	TPSTD-015
4	20 g	lead	steel	uncoated	100 pcs.	TPSTD-020
5	25 g	lead	steel	uncoated	100 pcs.	TPSTD-025
6	30 g	lead	steel	uncoated	100 pcs.	TPSTD-030
7	35 g	lead	steel	uncoated	100 pcs.	TPSTD-035
8	40 g	lead	steel	uncoated	100 pcs.	TPSTD-040
9	45 g	lead	steel	uncoated	100 pcs.	TPSTD-045
10	50 g	lead	steel	uncoated	50 pcs.	TPSTD-050
11	55 g	lead	steel	uncoated	50 pcs.	TPSTD-055
12	60 g	lead	steel	uncoated	50 pcs.	TPSTD-060

The information contained in the catalog does not constitute an offer within the meaning of the Civil Code, but an invitation to place orders and conclude a contract. The colors shown in the photo may differ from the original ones. The company is not responsible for any printing errors.

Lead knock-on weights for aluminum rims

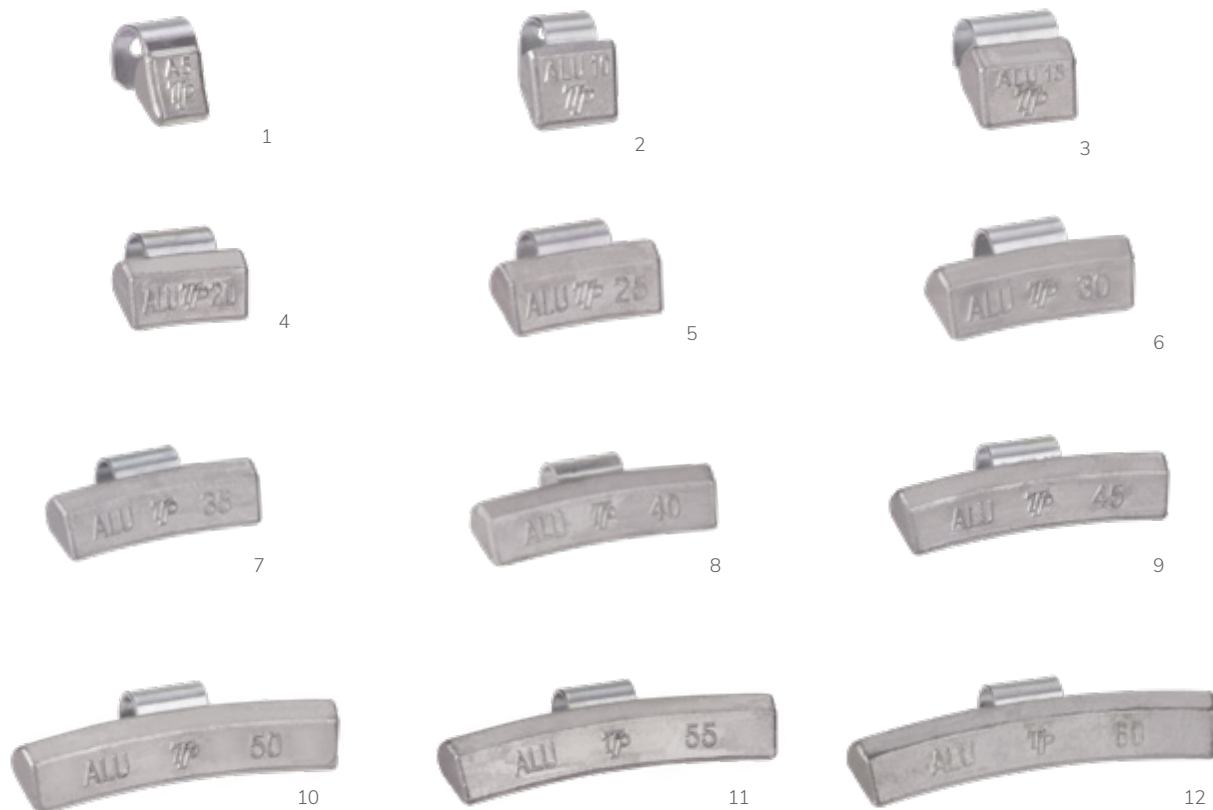

Rebranding
in progress

👁️	Weight	Material	Rim	Coating	Quantity	Index
1	5 g	lead	aluminum	uncoated	100 pcs.	TPALU-005
2	10 g	lead	aluminum	uncoated	100 pcs.	TPALU-010
3	15 g	lead	aluminum	uncoated	100 pcs.	TPALU-015
4	20 g	lead	aluminum	uncoated	100 pcs.	TPALU-020
5	25 g	lead	aluminum	uncoated	100 pcs.	TPALU-025
6	30 g	lead	aluminum	uncoated	100 pcs.	TPALU-030
7	35 g	lead	aluminum	uncoated	100 pcs.	TPALU-035
8	40 g	lead	aluminum	uncoated	100 pcs.	TPALU-040
9	45 g	lead	aluminum	uncoated	100 pcs.	TPALU-045
10	50 g	lead	aluminum	uncoated	50 pcs.	TPALU-050
11	55 g	lead	aluminum	uncoated	50 pcs.	TPALU-055
12	60 g	lead	aluminum	uncoated	50 pcs.	TPALU-060

Zinc knock-on weights for steel rims



👁️	Weight	Material	Rim	Coating	Quantity	Index
1	5 g	zinc	steel	uncoated	100 pcs.	TPZNSTD-005
2	10 g	zinc	steel	uncoated	100 pcs.	TPZNSTD-010
3	15 g	zinc	steel	uncoated	100 pcs.	TPZNSTD-015
4	20 g	zinc	steel	uncoated	100 pcs.	TPZNSTD-020
5	25 g	zinc	steel	uncoated	100 pcs.	TPZNSTD-025
6	30 g	zinc	steel	uncoated	100 pcs.	TPZNSTD-030
7	35 g	zinc	steel	uncoated	50 pcs.	TPZNSTD-035
8	40 g	zinc	steel	uncoated	50 pcs.	TPZNSTD-040
9	45 g	zinc	steel	uncoated	50 pcs.	TPZNSTD-045
10	50 g	zinc	steel	uncoated	50 pcs.	TPZNSTD-050
11	55 g	zinc	steel	uncoated	50 pcs.	TPZNSTD-055
12	60 g	zinc	steel	uncoated	50 pcs.	TPZNSTD-060

Zinc knock-on weights for steel rims



👁️	Weight	Material	Rim	Coating	Quantity	Index
1	5 g	zinc	steel	grey powder coating	100 pcs.	TPZNSTD-S-005
2	10 g	zinc	steel	grey powder coating	100 pcs.	TPZNSTD-S-010
3	15 g	zinc	steel	grey powder coating	100 pcs.	TPZNSTD-S-015
4	20 g	zinc	steel	grey powder coating	100 pcs.	TPZNSTD-S-020
5	25 g	zinc	steel	grey powder coating	100 pcs.	TPZNSTD-S-025
6	30 g	zinc	steel	grey powder coating	100 pcs.	TPZNSTD-S-030
7	35 g	zinc	steel	grey powder coating	50 pcs.	TPZNSTD-S-035
8	40 g	zinc	steel	grey powder coating	50 pcs.	TPZNSTD-S-040
9	45 g	zinc	steel	grey powder coating	50 pcs.	TPZNSTD-S-045
10	50 g	zinc	steel	grey powder coating	50 pcs.	TPZNSTD-S-050

Zinc knock-on weights for aluminum rims



👁️	Weight	Material	Rim	Coating	Quantity	Index
1	5 g	zinc	aluminum	grey powder coating	100 pcs.	TPZNALU-S-005
2	10 g	zinc	aluminum	grey powder coating	100 pcs.	TPZNALU-S-010
3	15 g	zinc	aluminum	grey powder coating	100 pcs.	TPZNALU-S-015
4	20 g	zinc	aluminum	grey powder coating	100 pcs.	TPZNALU-S-020
5	25 g	zinc	aluminum	grey powder coating	100 pcs.	TPZNALU-S-025
6	30 g	zinc	aluminum	grey powder coating	100 pcs.	TPZNALU-S-030
7	35 g	zinc	aluminum	grey powder coating	50 pcs.	TPZNALU-S-035
8	40 g	zinc	aluminum	grey powder coating	50 pcs.	TPZNALU-S-040
9	45 g	zinc	aluminum	grey powder coating	50 pcs.	TPZNALU-S-045
10	50 g	zinc	aluminum	grey powder coating	50 pcs.	TPZNALU-S-050

Lead knock-on weights for truck steel rims



👁	Weight	Material	Rim	Coating	Quantity	Index
1	50 g	lead	steel	uncoated	20 pcs.	TPTBL-050
2	75 g	lead	steel	uncoated	20 pcs.	TPTBL-075
3	100 g	lead	steel	uncoated	20 pcs.	TPTBL-100
4	150 g	lead	steel	uncoated	20 pcs.	TPTBL-150
5	200 g	lead	steel	uncoated	20 pcs.	TPTBL-200
6	250 g	lead	steel	uncoated	20 pcs.	TPTBL-250
7	300 g	lead	steel	uncoated	20 pcs.	TPTBL-300
8	350 g	lead	steel	uncoated	10 pcs.	TPTBL-350
9	400 g	lead	steel	uncoated	10 pcs.	TPTBL-400
10	500 g	lead	steel	uncoated	10 pcs.	TPTBL-500

Lead knock-on weights for spoke motorcycle rims



Diameter of hole 5,5 and 6,2 mm, diameters of spoke 6,0 and 6,4 mm.



Eye	Weight	Material	Rim	Coating	Quantity	Index
1	10 g	lead	for spoke	uncoated	50 pcs.	HF713-010
2	15 g	lead	for spoke	uncoated	50 pcs.	HF713-015
3	20 g	lead	for spoke	uncoated	50 pcs.	HF713-020

Lead adhesive weights for aluminum motorcycle rims

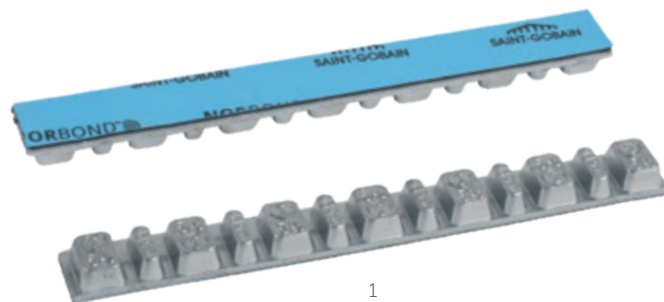

Eye	Weight	Material	Rim	Shape	Coating	Color	Height	Tape	Quantity	Index
1	50 g: 7x5 g + 6x2,5 g	lead	aluminum	rounded	uncoated	silver	7 mm	black	100 pcs.	HF715-5-050

Lead adhesive weights for aluminum rims



Rebranding in progress

Eye	Weight	Material	Rim	Shape	Coating	Color	Height	Tape	Quantity	Index
1	60 g: 4x10 g + 4x5 g	lead	aluminum	square	uncoated	silver	4 mm	black	100 pcs.	TPALUSLIM

Steel adhesive weights for aluminum rims



👁️	Weight	Material	Rim	Shape	Coating	Color	Height	Tape	Quantity	Index
1	60 g: 12x5 g	steel	aluminum	square	zinc plated	silver	4 mm	black	100 pcs.	TPALU-FE1
2	60 g: 12x5 g	steel	aluminum	square	zinc plated + powder coating	grey	4 mm	black	100 pcs.	TPALU-FE1C
3	60 g: 12x5 g	steel	aluminum	square	zinc plated + powder coating	black	4 mm	black	100 pcs.	TPALU-FE1B

Steel adhesive weights for aluminum rims with the innovative NO TRACE tape



👁️	Weight	Material	Rim	Shape	Coating	Color	Height	Tape	Quantity	Brand	Index
1	60 g: 12x5 g	steel	aluminum	rounded	zinc plated	silver	4 mm	blue	100 pcs.	INVENTO	TPALU-FE1NT
2	60 g: 12x5 g	steel	aluminum	rounded	zinc plated + powder coating	grey	4 mm	blue	100 pcs.	INVENTO	TPALU-FE1NTC
3	60 g: 12x5 g	steel	aluminum	rounded	zinc plated + powder coating	black	4 mm	blue	100 pcs.	INVENTO	TPALU-FE1NTB
	60 g: 12x5 g	steel	aluminum	rounded	zinc plated	silver	4 mm	blue	100 pcs.	neutral	EXPTPALU-FE1NT
	60 g: 12x5 g	steel	aluminum	rounded	zinc plated + powder coating	grey	4 mm	blue	100 pcs.	neutral	EXPTPALU-FE1NTC
	60 g: 12x5 g	steel	aluminum	rounded	zinc plated + powder coating	black	4 mm	blue	100 pcs.	neutral	EXPTPALU-FE1NTB

Steel adhesive weights for aluminum rims

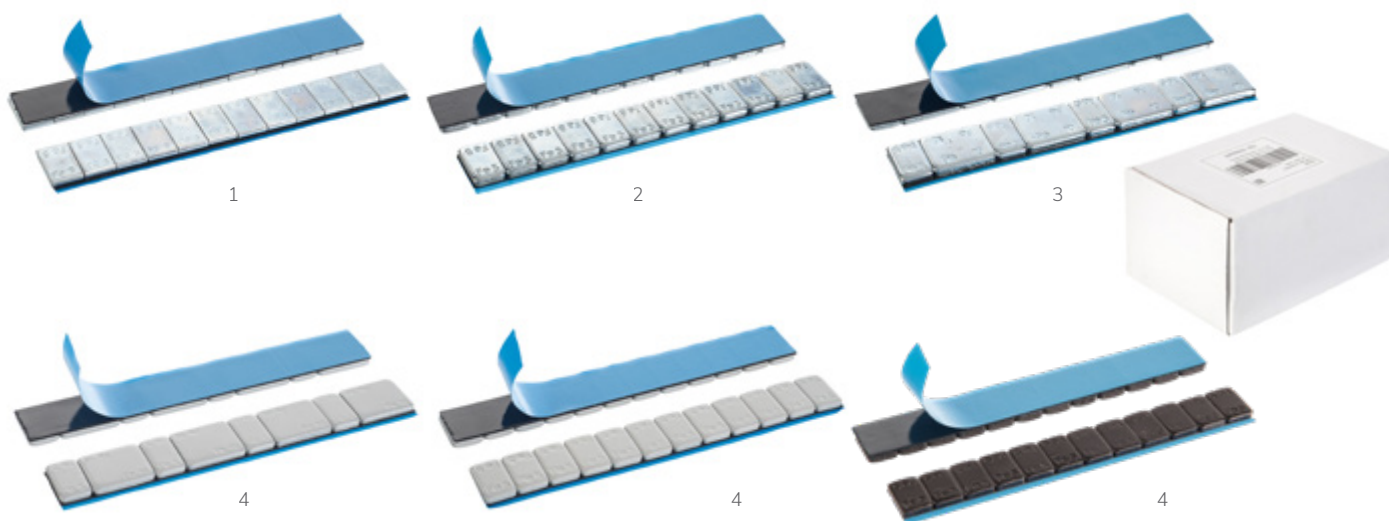

Weight	Material	Rim	Shape	Coating	Color	Height	Tape	Quantity	Index	
1	60 g: 12x5 g	steel	aluminum	square	zinc plated	silver	4 mm	black	100 pcs.	EXPTPALU-FE1
2	60 g: 12x5 g	steel	aluminum	rounded	zinc plated	silver	4 mm	black	100 pcs.	TPALU-FE-ECO
3	60 g: 4x10 g + 4x5 g	steel	aluminum	rounded	zinc plated	silver	4 mm	black	100 pcs.	TPALU-FE-ECO2
4	60 g: 4x10 g + 4x5 g	steel	aluminum	rounded	zinc plated + power coating	grey	4 mm	black	100 pcs.	EXPTPALU-FE-ECO2C
4	60 g: 12x5 g	steel	aluminum	rounded	zinc plated + power coating	grey	4 mm	black	100 pcs.	EXPTPALU-FE1C
4	60 g: 12x5 g	steel	aluminum	rounded	zinc plated + power coating	black	4 mm	black	100 pcs.	EXPTPALU-FE1B



Weight	Material	Rim	Shape	Coating	Color	Height	Tape	Quantity	Index	
1	60 g: 12x5 g	steel	aluminum	square	zinc plated + powder coating	silver	4 mm	black	50 pcs.	TPALU-FE 12x5g
2	30 g: 12x2,5 g	steel	aluminum	square	zinc plated + powder coating	silver	2,7 mm	black	100 pcs.	TPALU-FE3

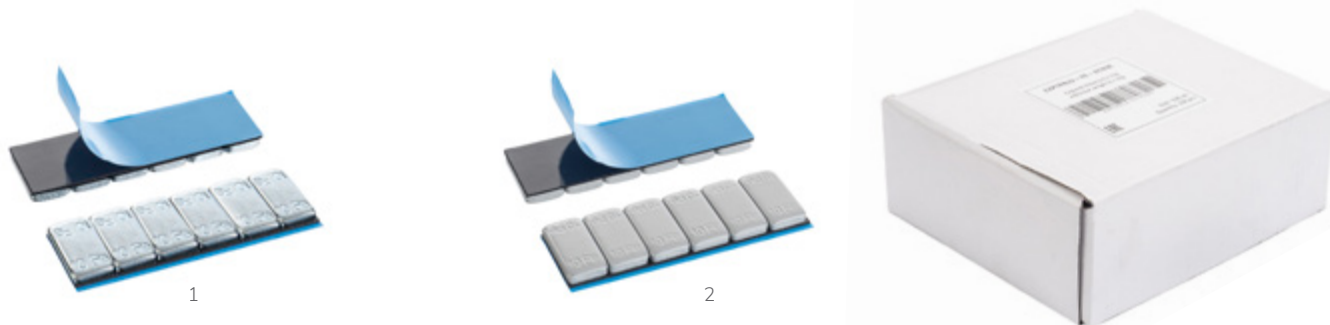

Weight	Material	Rim	Shape	Coating	Color	Height	Tape	Quantity	Index	
1	60 g: 6x10 g	steel	aluminum	rounded	zinc plated	silver	4 mm	black	100 pcs.	EXPTPALU-FE-ECO3
2	60 g: 6x10 g	steel	aluminum	rounded	zinc plated + powder coating	grey	4 mm	black	100 pcs.	EXPTPALU-FE-ECO3C

Steel adhesive weights for aluminum rims, roll



1



2

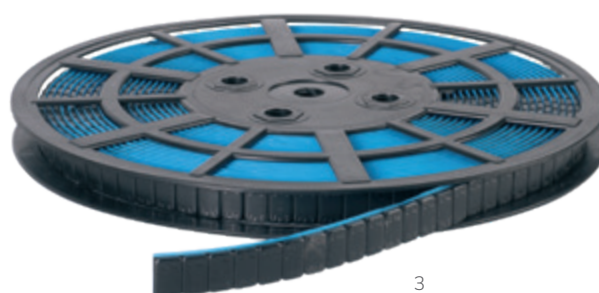

3



	Weight	Material	Rim	Shape	Coating	Color	Height	Tape	Quantity	Index
1	6 kg: 1200x5 g	steel	aluminum	rounded	zinc plated	silver	4 mm	black	1 pcs.	TPALU-FE4
2	6 kg: 1200x5 g	steel	aluminum	rounded	zinc plated + powder coating	grey	4 mm	black	1 pcs.	EXPTPALU-FE4C
3	6 kg: 1200x5 g	steel	aluminum	rounded	zinc plated + powder coating	black	4 mm	black	1 pcs.	EXPTPALU-FE4B

Steel adhesive weights for aluminum rims with the innovative NO TRACE tape, roll

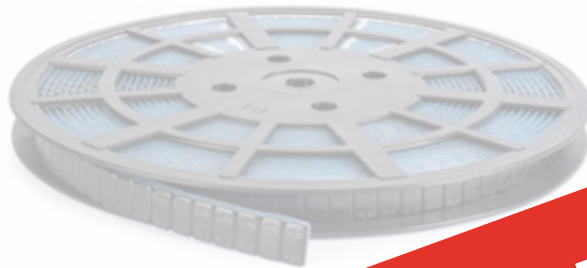
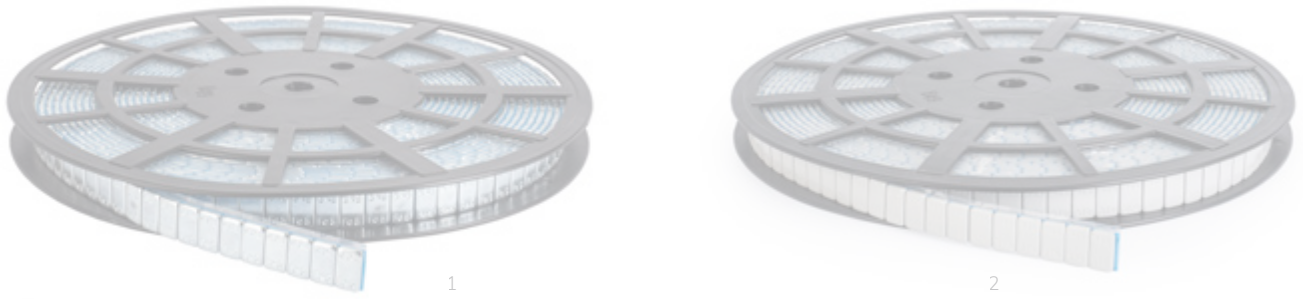

👁️	Weight	Material	Rim	Shape	Coating	Color	Height	Tape	Quantity	Brand	Index
1	6 kg: 1200x5 g	steel	aluminum	rounded	zinc plated	silver	4 mm	blue	1 pcs.	INVENTO	TPALU-FE4NT
2	6 kg: 1200x5 g	steel	aluminum	rounded	zinc plated + powder coating	grey	4 mm	blue	1 pcs.	INVENTO	TPALU-FE4NTC
3	6 kg: 1200x5 g	steel	aluminum	rounded	zinc plated + powder coating	black	4 mm	blue	1 pcs.	INVENTO	TPALU-FE4NTB
	6 kg: 1200x5 g	steel	aluminum	rounded	zinc plated	silver	4 mm	blue	1 pcs.	neutral	EXPTPALU-FE4NT
	6 kg: 1200x5 g	steel	aluminum	rounded	zinc plated + powder coating	grey	4 mm	blue	1 pcs.	neutral	EXPTPALU-FE4NTC
	6 kg: 1200x5 g	steel	aluminum	rounded	zinc plated + powder coating	black	4 mm	blue	1 pcs.	neutral	EXPTPALU-FE4NTB

Lead adhesive weights for truck aluminum rims

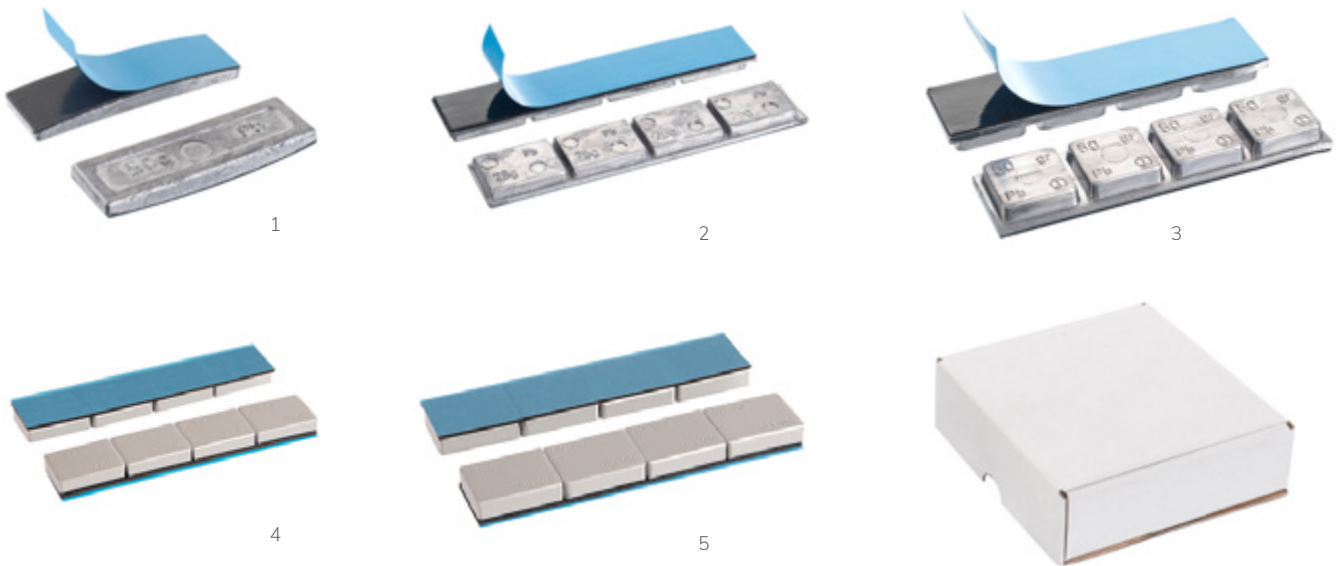

👁	Weight	Material	Rim	Shape	Coating	Color	Height	Tape	Quantity	Index
1	50 g	lead	aluminum	square	uncoated	silver	6 mm	black	10 pcs.	TPALUTR-050
	75 g	lead	aluminum	square	uncoated	silver	8 mm	black	10 pcs.	TPALUTR-075
	100 g	lead	aluminum	square	uncoated	silver	10 mm	black	10 pcs.	TPALUTR-100
	125 g	lead	aluminum	square	uncoated	silver	8 mm	black	10 pcs.	TPALUTR-125
	150 g	lead	aluminum	square	uncoated	silver	10 mm	black	10 pcs.	TPALUTR-150
	175 g	lead	aluminum	square	uncoated	silver	8 mm	black	10 pcs.	TPALUTR-175
	200 g	lead	aluminum	square	uncoated	silver	13 mm	black	10 pcs.	TPALUTR-200
	250 g	lead	aluminum	square	uncoated	silver	13 mm	black	10 pcs.	TPALUTR-250
	300 g	lead	aluminum	square	uncoated	silver	13 mm	black	10 pcs.	TPALUTR-300
2	100 g: 4x25 g	lead	aluminum	square	uncoated	silver	6 mm	black	25 pcs.	TPALUTRUCK-100
3	200 g: 4x50 g	lead	aluminum	square	uncoated	silver	9 mm	black	25 pcs.	TPALUTRUCK-200
4	100 g: 4x25 g	steel	aluminum	square	zinc plated + powder coating	grey	7 mm	black	50 pcs.	EXPTPALU-FE-TRUCK100
5	200 g: 4x50 g	steel	aluminum	square	zinc plated + powder coating	grey	9 mm	black	30 pcs.	EXPTPALU-FE-TRUCK200

Tyre balancing powders



👁	Description	Weight	Index
1	Tyre balancing powder TIP-TOPOL ORBIS	8 kg	566-0200
2	Tyre balancing powder	25 kg	566-2500

Adhesive tape remover spray



1

👁 Description		Capacity	Index
1 Adhesive tape remover spray STR1000	ECONOMY	500 ml	593-070519

Adhesive tape remover discs



1



2

👁 Description		Diameter	Index
1 Rubber disc		80 mm	CP7035AD
2 Notched rubber disc		100 mm	CP7035KS

Special tools and accessories



1



2



3



4



5

👁 Description		Index
1 Plastic scraper		EXP565-4469
2 Silicon pressure roller		518-8000
3 Wheel weight pliers	PREMIUM	518-7801
4 Wheel weight pliers		518-7900
5 Stand for adhesive wheel weights		TP100-000

Rubber tubeless tyre valves



1



2



3

👁	Description	Rim hole	ETRTO/TR	Index
1	Valve TR 438	8,3 mm	V2.03.5	562-2500
2	Valve TR 70 angled	11,3 mm	TR 70	562-2531
3	Valve PVR 30 angled	11,3 mm	-	562-2532

Metal tubeless tyre valves



1



2

👁	Description	Rim hole	Installation torque	Index
1	Metal valve 33 MS	8,3 mm	3-5 Nm	562-2603
2	Metal valve angled - 90°	8,3 mm	3-5 Nm	562-2830

Tube valves



1



2

👁	Description	Rubber base	ETRTO/TR	Index
1	Valve GP 4	45 mm	V1.09.1	562-3207
2	Valve SP 4	18 mm	V1.05.1	562-1006

Snap-in tubeless valves



👁️	Description	Rim hole	Length	Max. pressure	Stem	Quantity	Index
1	Snap-in valve TR 413 Standard TUV	11,3 mm	43 mm	4,5 bar	aluminum	100 pcs.	EXP562-2627-A
2	Snap-in valve TR 414 Standard TUV	11,3 mm	49 mm	4,5 bar	aluminum	100 pcs.	EXP562-2555-A



👁️	Description	Rim hole	Length	Max. pressure	ETRTO	Stem	Quantity	Index
1	Snap-in valve TR 413 Premium	11,3 mm	43 mm	4,5 bar	V2.03.1	brass	100 pcs.	562-2627
2	Snap-in valve TR 414 Premium	11,3 mm	49 mm	4,5 bar	V2.03.2	brass	100 pcs.	562-2555



👁️	Description	Rim hole	Length	Max. pressure	ETRTO	Stem	Quantity	Index
1	Snap-in valve TR 413 Premium TUV	11,3 mm	43 mm	4,5 bar	V2.03.1	brass	100 pcs.	EXP562-2627
2	Snap-in valve TR 414 Premium TUV	11,3 mm	49 mm	4,5 bar	V2.03.2	brass	100 pcs.	EXP562-2555
	Snap-in valve TR 413 Premium TUV set unmounted	11,3 mm	43 mm	4,5 bar	V2.03.1	brass	100 pcs.	EXP562-2627ZT
3	Snap-in valve TR 414 Premium TUV set unmounted	11,3 mm	49 mm	4,5 bar	V2.03.2	brass	100 pcs.	EXP562-2555ZT



👁️	Description	Rim hole	Length	Max. pressure	ETRTO	Stem	Quantity	Index
1	Snap-in valve TR 413 Premium Alligator	11,3 mm	43 mm	4,5 bar	V2.03.1	brass	100 pcs.	562-2628
2	Snap-in valve TR 414 Premium Alligator	11,3 mm	49 mm	4,5 bar	V2.03.2	brass	100 pcs.	562-2556



👁️	Description	Rim hole	Length	Max. pressure	ETRTO	Stem	Quantity	Index
1	Snap-in valve TR 412 Premium	11,3 mm	33 mm	4,5 bar	V2.03.6	brass	100 pcs.	562-2641
2	Snap-in valve TR 414L Premium	11,3 mm	57 mm	4,5 bar	V2.03.8	brass	100 pcs.	562-2524
3	Snap-in valve TR 415 Premium	15,7 mm	43 mm	4,5 bar	V2.03.3	brass	100 pcs.	562-2634
4	Snap-in valve TR 418 Premium	11,3 mm	61,5 mm	4,5 bar	V2.03.4	brass	100 pcs.	562-2562

Rubber valve with chrome sleeve



👁 Description	Rim hole	Length	Max. pressure	Index
1 Rubber valve TR 412 - Chrome	11,3 mm	34 mm	4,5 bar	562-2801
2 Rubber valve TR 413 - Chrome	11,3 mm	43 mm	4,5 bar	562-2809
3 Rubber valve TR 414 - Chrome	11,3 mm	49 mm	4,5 bar	562-2816

Metal tubeless tyre valves



👁 Description	Installation torque	Rim hole	ETRTO / TR	Index
1 Metal valve 40 MS	3 - 5 Nm	15,7 mm	TR 416	562-2610
2 Metal valve 42 MS / 525 MSD	4 - 6 Nm	11,3 mm	-	562-2658
3 Metal valve 42 MS / 525 MSK	4 - 6 Nm	11,3 mm	-	562-2672
4 Metal valve 38,5 MS	5 - 7 Nm	8,3 mm	-	562-2713
5 Valve 42 MS/525 AL	4 - 6 Nm	11,3 mm	-	562-2782
6 Valve 43 MS black	4 - 6 Nm	11,3 mm	-	562-2790B
7 Valve 43 MS grey	4 - 6 Nm	11,3 mm	-	562-2790G

Flush mount valves



👁 Description	Rim hole	ETRTO / TR	Index
1 Valve V007	11,3 mm	-	562-2699
Valve V007	8,3 mm	-	562-2709

High-pressure snap-in tubeless tyre valves



👁	Description		Rim hole	Total length	Max. pressure	ETRTO	Index
1	Rubber valve HP 600	PREMIUM	11,3 mm	43,8 mm	5,5 bar	V3.23.1	562-2650
2	Rubber valve HP 602	PREMIUM	11,3 mm	62,4 mm	5,5 bar	V3.23.2	562-2651
3	Rubber valve CVV 47	PREMIUM	11,3 mm	47,5 mm	7 bar	-	562-2150

Tube valves

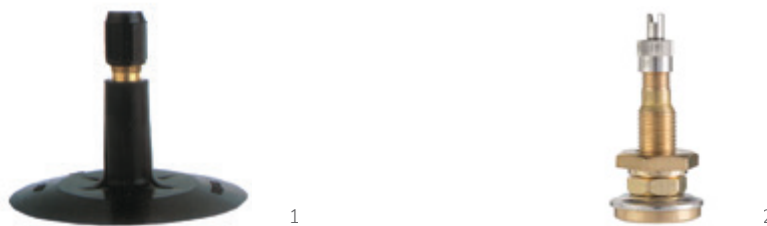

👁	Description	Installation torque	Rim hole	ETRTO / TR	Index
1	Valve GP 5	-	11,3 mm	V2.01.1 / TR13	562-3212
	Valve GP 5	-	15,7 mm	V2.01.2 / TR15	562-3219
2	Valve SP 5	7 - 10 Nm	23 mm	TR17A	562-1202

Air/water rim valves



👁	Description	Rubber base	ETRTO / TR	Index
1	Valve GP 6	63,5 mm	V4.01.1	562-3224
2	Valve SP 6	31,5 mm		562-3008
3	Valve SP 7	31,5 mm		562-3011

Valve core housing for air/water rim valves



1



2

👁	Description	Symbol wg ETRTO / TR	Index
1	Core housing GP 6, SP 7, TR 218	CH1	562-3042
2	Core housing GP 6, SP 7, TR 218A	V4.02.1 / CH3	562-3066

Screw-on valves for trucks



During the tyre disassembly, the seal must be replaced.

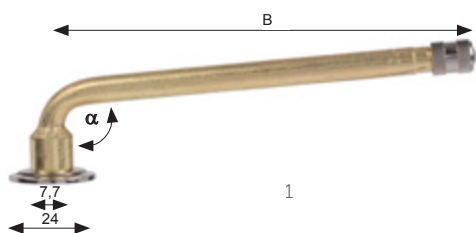

1



2



3

👁	Description	Length (B)	Angle of deflection (α)	Symbol wg ETRTO / TR	Index
	Valve GW4A	50 mm	90°	V3.02.5	562-7392
	Valve GW4A	75 mm	94°	V3.02.27	562-7402
	Valve GW4A	95 mm	94°	V3.02.8 / 177eq	562-7433
1	Valve GW4A	115 mm	94°	V3.02.10 / 175eq	562-7464
	Valve GW4A	127 mm	94°	V3.02.11 / 78eq	562-7471
	Valve GW4A	140 mm	94°	V3.02.14 / 179eq	562-7495
2	Rubber seal diameter 24 mm			V9.05.1	562-2768
3	Rubber base 80mm for „HOT“ applikation			V3.08.3	563-1948

Inner tube valves



Used with rubber bases prepared for "COLD" application.



1



2

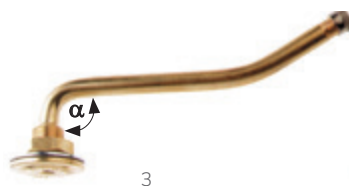

3



4

👁	Description	Length	Angle of deflection (α)	Symbol wg ETRTO / TR	Index
1	Valve SW 1	60 mm	50°	-	562-1300
	Valve SW 1	43 mm	90°	-	562-1305
2	Valve SW 1	95 mm	90°	TR 76	562-1343
	Valve SW 1	115 mm	90°	-	562-1374
	Valve SW 1	138 mm	90°	-	562-1408
	Valve SW 2	35/40 mm	30°	-	562-1415
3	Valve SW 2	73/40 mm	30°	-	562-1422
4	Valve SW 3	65/42 mm	30°	-	562-1429

Tubeless valves



Eye	Description	Angle of deflection	Installation torque	Rim hole	ETRTO / TR	Index
1	Valve 41 MS	-	12 - 15 Nm	9,7 mm	V3.20.1	562-6805
2	Valve 58 MS	45°	12 - 15 Nm	9,7 mm	V3.22.1	562-6898
3	Valve 58 MS ALLIGATOR PREMIUM	45°	12 - 15 Nm	9,7 mm	V3.22.1	562-6898A
4	Valve 70 MS	27°	12 - 15 Nm	9,7 mm	V3.20.5	562-6812
	Valve 80 MS	27°	12 - 15 Nm	9,7 mm	V3.20.7	562-6820
	Valve 90 MS	27°	12 - 15 Nm	9,7 mm	V3.20.4	562-6829
5	Valve 102 MS	12°	12 - 15 Nm	9,7 mm	V3.20.9	562-6836
	Valve 100 MS	27°	12 - 15 Nm	9,7 mm	V3.20.12	562-6850
	Valve 119 MS	12°	12 - 15 Nm	9,7 mm	V3.20.8	562-6843
	Valve 119 MS	27°	12 - 15 Nm	9,7 mm	V3.20.6	562-6867

Tubeless valves for aluminum rims



Eye	Description	Angle of deflection	Installation torque	Rim hole	ETRTO / TR	Index
1	Valve 59 MS - ALU - 543 C	45°	9 - 14 Nm	9,7 mm	TR 543C	562-6568
2	Valve 70 MS - ALCOA	7°	9 - 14 Nm	9,7 mm	-	562-6680
3	Valve 70 MS - ALCOA	27°	9 - 14 Nm	9,7 mm	-	562-6690
4	Valve 60 MS - ALCOA PREMIUM	-	12 - 15 Nm	9,7 mm	-	562-6679W
5	Valve 54 MS - ALCOA PREMIUM	-	12 - 15 Nm	9,7 mm	-	562-6675W
6	Valve 40 MS - ALCOA PREMIUM	-	12 - 15 Nm	9,7 mm	-	562-6670W
7	Valve MS 36	-	9 - 14 Nm	11,5 mm	V2.04.1	562-6599

Tubeless valves, MS type, straight



👁	Description	Length	Installation torque	Rim hole	ETRTO / TR	Index
	Valve 32 MS	29 mm	3 - 5 Nm	16 mm	V3.21.1 / 575	562-9716
	Valve 32 MS Alligator PREMIUM	33 mm	3 - 5 Nm	16 mm	V3.21.1 / 575	562-9716A
1	Valve 42 MS	38 mm	3 - 5 Nm	16 mm	V3.21.2 / 501	562-9723
	Valve 54 MS	51 mm	3 - 5 Nm	16 mm	V3.21.3 / 500	563-5016
2	Valve 84 MS	80 mm	3 - 5 Nm	16 mm	V3.21.4 / 570	563-5023
	Valve 89 MS	86 mm	3 - 5 Nm	16 mm	V3.21.5 / 571	563-5030

Tubeless valves, MS type, angled

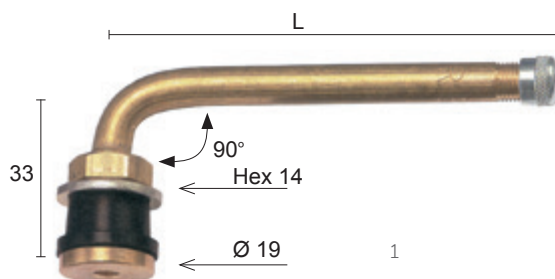

👁	Description	Length (L)	Installation torque	Rim hole	ETRTO / TR	Index
1	Valve 89 MS - 90°	58 mm	3 - 5 Nm	16 mm	V3.21.10 / 571 C	562-9730
	Valve 114 MS - 90°	83 mm	3 - 5 Nm	16 mm	V3.21.12 / 573 C	562-6764

Tubeless valves, Y type

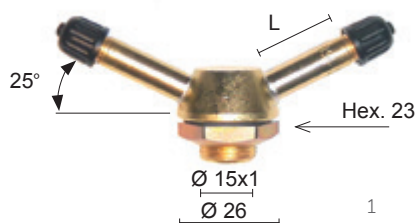

👁	Description	Length (L)	Installation torque	Rim hole	ETRTO / TR	Index
1	Double valve, Y type	30 mm	25 - 31 Nm	16 mm	-	562-6647

Tubeless valves, MSF type

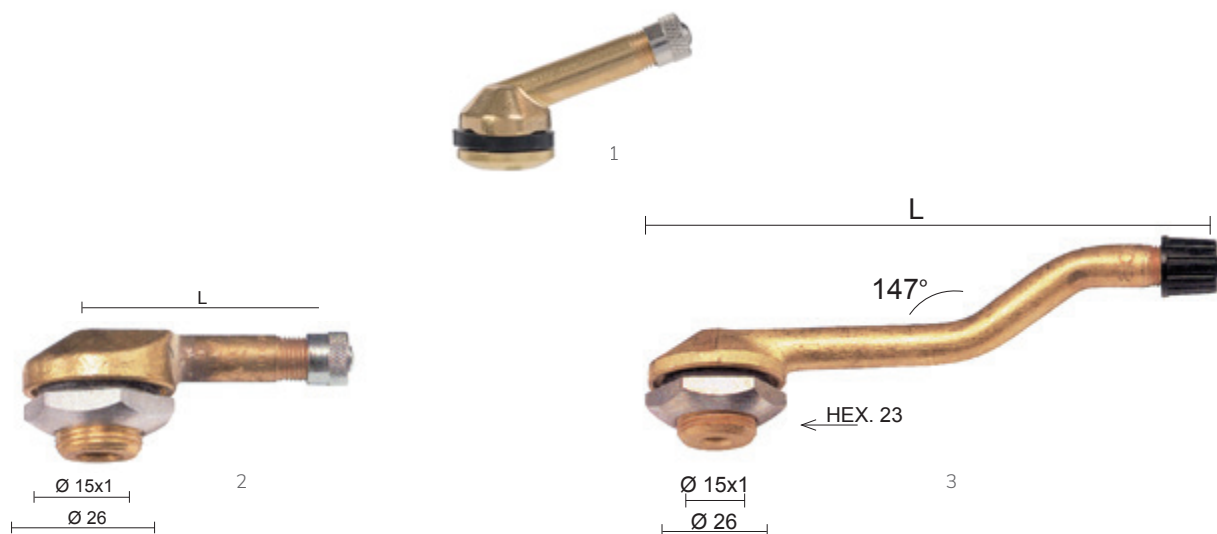

👁	Description	Length (L)	Installation torque	Rim hole	ETRTO / TR	Index
1	Valve 35 MSF	-	25 - 31 Nm	16 mm	V0.09.3	562-6616
2	Valve 40 MSF	40 mm	25 - 31 Nm	16 mm	V3.12.1	562-6609
	Valve 95 MSF	95 mm	25 - 31 Nm	16 mm	V3.12.2	562-6795
	Valve 75 MSF	72 mm	25 - 31 Nm	16 mm	V3.14.1	562-6733
3	Valve 75 MSF WONDER PREMIUM	72 mm	25 - 31 Nm	16 mm	V3.14.1	562-6733W
	Valve 85 MSF	83 mm	25 - 31 Nm	16 mm	V3.14.3	562-6771
	Valve 95 MSF	91 mm	25 - 31 Nm	16 mm	V3.14.2	562-6788
	Valve 110 MSF	105 mm	25 - 31 Nm	16 mm	-	562-6881

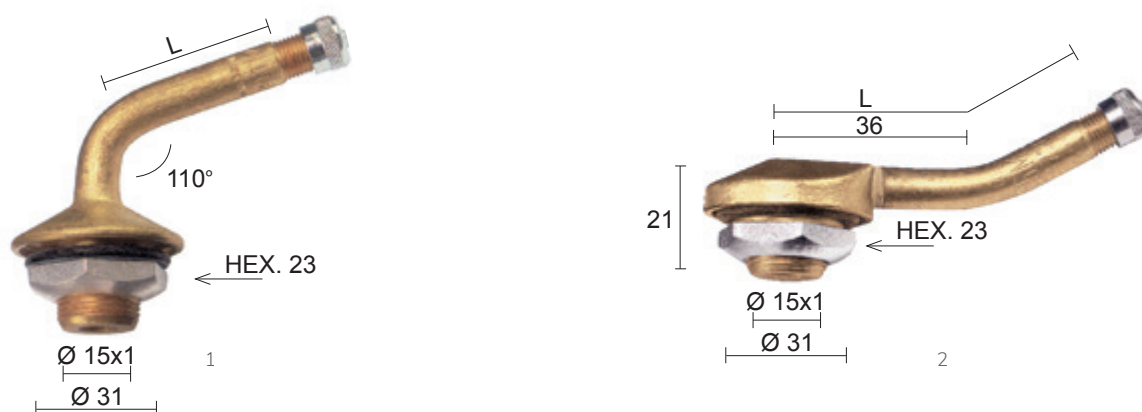

👁	Description	Length (L)	Installation torque	Rim hole	ETRTO / TR	Index
1	Valve 44 MSF	44,5 mm	25 - 31 Nm	20,5 mm	V3.15.1	562-6654
	Valve 44 MSF	44,5 mm	25 - 31 Nm	20,5 mm	V3.15.2	562-6655
2	Valve 65 MSF	65 mm	25 - 31 Nm	20,5 mm	V3.16.1	562-6946

Tubeless valves, MSF type

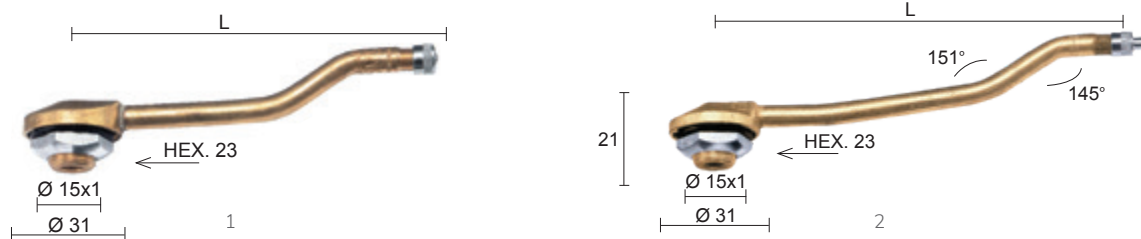

👁	Description	Length (L)	Installation torque	Rim hole	ETRTO / TR	Index
1	Valve 115 MSF	117 mm	25 - 31 Nm	20,5 mm	V3.18.1	562-6953
	Valve 130 MSF	133 mm	25 - 31 Nm	20,5 mm	V3.18.2	562-6939
2	Valve 140 MSF	140 mm	25 - 31 Nm	20,5 mm	V3.19.1	562-6915

Air-water tyre valves for tractors



Metal valves for air/water filling.



👁	Description	Length	Installation torque	Rim hole	ETRTO / TR	Index
1	Rubber valve A 35 GWS	56 mm	-	16 mm		562-3035
2	Valve TR 618 A - 50 MSW	50 mm	5 - 8 Nm	16 mm	V5.01.1 / TR618A	562-3080
3	Valve TR 621 A - 65°	75 mm	5 - 8 Nm	16 mm	V5.02.1 / TR621A	562-3097
4	Valve TR 622 A - 90°	115 mm	5 - 8 Nm	16 mm	V5.02.2 / TR622A	562-3107
	Valve TR 623 A - 65°	57 mm	5 - 8 Nm	16 mm	V5.02.3 / TR623A	562-3114

Tube valves, EM TRJ type



👁	Description	Length	Index
1	Valve straight EM TRJ 1014	53 mm	562-9204
	Valve angled EM TRJ 1175 A	115 mm	562-9205
2	Valve angled EM TRJ 1179 B	141 mm	562-9206

Tubeless valves, EM TRJ type



👁	Description	Length	Rim hole	ETRTO / TR	Index
1	Valve EM TRJ 670-03	56 mm	20,5 mm	V5.03.1	562-9709
2	Valve EM TRJ 653-03 - 100°	64 mm	20,5 mm	-	562-9606
	Valve EM TRJ 654-03 - 120°	57 mm	20,5 mm	-	562-9613
	Valve EM TRJ 655-03 - 106°	75 mm	20,5 mm	-	562-9620
3	Valve EM TRJ 650-03 - 100°	115 mm	20,5 mm	V5.04.1	562-9637
4	Valve EM TRJ 651-03 - 90°	119 mm	20,5 mm	V5.04.2	562-9644
	Valve EM TRJ 652-03 - 94°	140 mm	20,5 mm	-	562-9651

Valve extensions, rigid, angled



Installation torque: 0,3 – 0,5 Nm.



👁	Description	Length (L)	Index
1	Valve extension, angled	34 mm	562-4292
	Valve extension, angled 45°	29 mm	562-4333
2	Valve extension, angled 45° - WONDER PREMIUM	29 mm	562-4333W

Valve extensions, rigid, straight



Installation torque: 0,4 – 0,7 Nm.

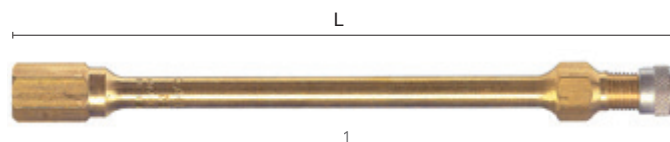

👁	Description	Length (L)	Index
	Valve extension, straight	34 mm	562-4010
	Valve extension, straight	77 mm	562-4034
1	Valve extension, straight	115 mm	562-4089
	Valve extension, straight	125 mm	562-4041

Valve extensions, rigid, plastic version



Installation torque: 0,4 – 0,7 Nm.

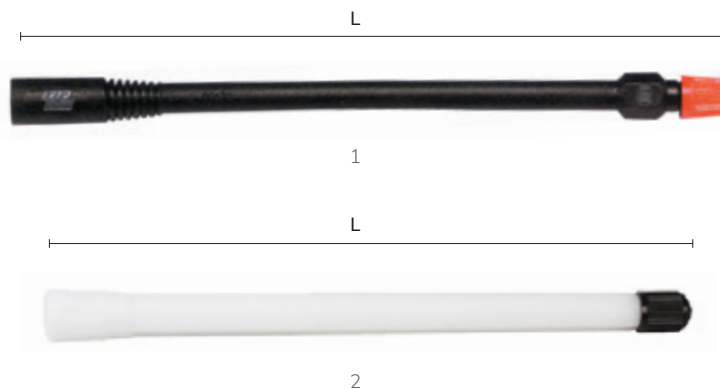

👁	Description	Length (L)	Index
	Valve extension, plastic version, black	70 mm	562-4553
1	Valve extension, plastic version, black	115 mm	562-4560
2	Valve extension, plastic version, white	115 mm	562-456B
	Valve extension, plastic version, black	150 mm	562-4577
	Valve extension, plastic version, black	170 mm	562-4584
	Valve extension, plastic version, white	170 mm	562-458B

Flexible extensions, straight



Installation torque: 0,3 – 0,5 Nm.



👁	Description	Length (L)	Index
	Flexible extension	75 mm	562-4216
	Flexible extension	105 mm	562-4223
	Flexible extension	115 mm	562-4230
	Flexible extension	125 mm	562-4247
	Flexible extension	140 mm	562-4254
1	Flexible extension - WONDER PREMIUM	140 mm	562-4254W
2	Flexible extension	180 mm	562-4261
	Flexible extension - WONDER PREMIUM	180 mm	562-4261W
	Flexible extension	210 mm	562-4278
	Flexible extension	270 mm	562-4285

Flexible extensions, angled



Installation torque: 0,3 – 0,5 Nm.

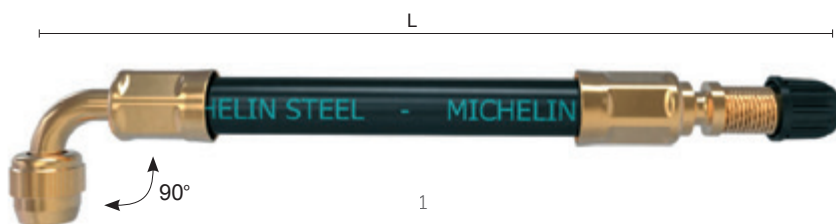

👁 Description		Length (L)	Index
1 Flexible extension, angled 90°	PREMIUM	250 mm	562-4281W**

Stainless steel braided flexible extensions, straight



Installation torque: 0,3 – 0,5 Nm.

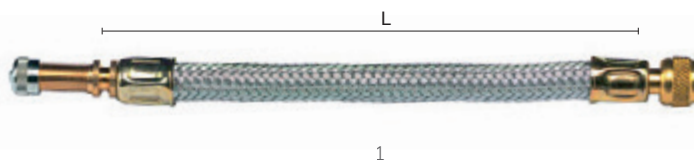

👁 Description		Length (L)	Index
Stainless steel braided flexible extension		125 mm	562-4405
Stainless steel braided flexible extension		140 mm	562-4412
1 Stainless steel braided flexible extension		160 mm	562-4420
Stainless steel braided flexible extension		180 mm	562-4429
Stainless steel braided flexible extension		210 mm	562-4436
Stainless steel braided flexible extension		300 mm	562-4450**

HOLDERS for flexible valve extensions



1



2



3

👁 Description		Index
1 Extension holder, double	ECONOMY	562-4182
2 Extension holder, double - WONDER	PREMIUM	562-4182W**
3 Extension holder		562-4199

** on request

Valve cores



1



2



3



4

👁	Description		Length	Installation torque	Index
	Valve core, short - Nickel-plated ALLIGATOR	PREMIUM	19 mm	0,4 - 0,5 Nm	562-0045
1	Valve core, short - Nickel-plated		19 mm	0,4 - 0,5 Nm	562-0046
	Valve core, short - Brass ALLIGATOR	PREMIUM	19 mm	0,4 - 0,5 Nm	562-0051
2	Valve core, short - Brass		19 mm	0,4 - 0,5 Nm	562-0052
3	Valve core, short EM		28 mm	0,5 - 07 Nm	562-0083
4	Express valve with black cap		26 mm		562-0612

Valve caps



1



2



3



4



5



6



7



8



9

👁	Description	Color	Quantity	Installation torque	Index
1	Nickel-plated cap, A type	silver	1 pcs.	0,2 - 0,3 Nm	562-0100
2	Valve cap	silver	1 pcs.	0,2 - 0,3 Nm	562-0203
3	Plastic cap	black	100 pcs.	0,2 - 0,3 Nm	562-0296
	Plastic cap with sealing	black	1 pcs.	0,2 - 0,3 Nm	562-0296G
4	Plastic cap	red	100 pcs.	0,2 - 0,3 Nm	562-0306
5	Plastic cap	green	100 pcs.	0,2 - 0,3 Nm	562-0313
6	Plastic cap	yellow	100 pcs.	0,2 - 0,3 Nm	562-0320
7	Plastic cap	blue	100 pcs.	0,2 - 0,3 Nm	562-0337
8	Cap for SP 6 and SP 7 valves	black	1 pcs.	-	562-3009
9	Brass-plated cap EM - VG 12	gold	1 pcs.	0,3 - 0,5 Nm	562-0124

Valve adapters



1



2



3

👁	Description	Installation torque	Index
1	EM adapter, reducing VG12-VG8	0,3 - 0,5 Nm	562-0368
2	Bicycle valve adapter DUNLOP, with gasket to car pump	-	562-5002
	Bicycle valve adapter PRESTO, without gasket to car pump	-	562-5019
3	Bicycle valve adapter, with non-return valve to bicycle pump	-	562-5071

Valve repair tools



1



2



3

👁	Description	For external rethread	For internal thread	Index
1	Screw driver for valve cores	VG8 / VG12	VG5	562-8030
2	Screw driver for valve cores	VG12	VG8	562-8061
3	Valve repair tool PCL	VG8	VG5	PCLTVT- 0100

Tube deflator

Quick and complete extraction of air from car, truck and tractor tubes. Suitable for connection to all valve adapters.



1

👁	Description	Index
1	Tube deflator	562-8195

Water filling and draining fittings



1

👁	Description	Index
1	Hanauer mouse	562-3138

Valve fishing tool



1

👁	Description	Index
1	Valve fishing tool	562-8315

Air Connector 8v1



👁	Description	Hose Size	Index
1	Air Connector 8v1 WONDER	8 mm	562-5095
	Air Connector 8v1 WONDER	6 mm	562-5105
2	Air Connector 8v1 Alligator	9 mm	562-5239A
3	Air Connector 8v1 Gentilin	7 mm	GEN70123507
4	Air Connector 8v1 PCL	6,35 mm	PNPCLCH2H01
	Air Connector 8v1 PCL	7,9 mm	PNPCLCH2K01**
5	Air Connector 8v1 PCL female thread 1/4"		PNPCLC08-T73
6	Rubber seal for air connector 562-5239		562-5318

Air Connector EM



👁	Description	Hose Size	Index
1	Air Connector EM	8 mm	562-5088
2	Air Connector EM	8 mm	562-5291

Tyre Valve Connector



👁	Description	Length	Index
1	Tyre valve connector with male thread 7,7 mm and swivel dual foot chuck for standard bore and large bore valves	160 mm	562-6255
2	Twin hold-on tyre valve connector, female thread 1/4", Open End	240 mm	PNPCLC01-A03
3	Twin clip-on tyre valve connector, female thread 1/4", Open End	255 mm	PNPCLC03-A03

** on request

Tools for installation or removal of SNAP-IN tubeless valves



1



2

👁	Description	Index
1	Metal tyre valve remover	562-8311
2	Plastic tyre valve remover	562-8353

Core Tools



1



2



3



4



5



6

👁	Description	Index
1	Double end valve core tool type VG5 i VG8	562-8092
2	Double end valve core tool type VG5 and cap type A	562-8102
3	Double end valve core tool type VG5 and cap type A with magnet	562-8103
4	Single end valve core tool type VG5	562-8200
5	Single end valve core tool type VG5 with snap	562-8360
6	Valve core tool with snap for motorcycle with snap	562-8391

Valve core torque tools



1



2

👁	Description	Range	Index
1	TPMS, snap-in, metal valve core torque tool	0 - 0,25 Nm	562-8420
2	Metal valve core torque tool	0 - 0,45 Nm	562-8430

Universal sensors INVENTO

Sensors are programmable by Autel and INVENTO devices.



👁	Description	Range	Type of Valve	Brand	Index
1	INVENTO 1-Sensor	315/433 MHz	aluminum	INVENTO	INVTS01
2	INVENTO 1-Sensor	315/433 MHz	aluminum black	INVENTO	INVTS02
3	INVENTO 1-Sensor	315/433 MHz	rubber	INVENTO	INVTS03

Testers for TPMS sensors



👁	Description	Free update	Programmable sensors	Wi-Fi module	OBD module	Multi language	Comprehensive TPMS support (diagnostics, ID copying, automatic and manual creation)	Index
1	INVENTO TPMS80	For life	INVENT 1-Sensor	✗	✓	✓	✓	INVTS80

Testers for TPMS sensors



1



2



👁️	Description	Free update	Programmable sensors	Wi-Fi module	OBD module	Multi language	Comprehensive TPMS support (diagnostics, ID copying, automatic and manual creation)	Index
1	Autel Maxi TPMS TS508WF	For life	Autel MX-Sensor	✓	✓	✓	✓	562-3548WF
2	Mobiletron PT47	5 years	Mobiletron MoreSensor	✗	✓	✓	✓	W-MB-PT47

Tools for TPMS



1



2

👁️	Description	Index
1	Toolkit for TPMS sensors	W-BGS8889
2	Plastic cap for separating the valve from the sensor	562-3990

Universal TPMS sensors



👁️	Description	Range	Type of valve	Brand	Index
1	MX-Sensor	433 MHz	aluminum	Autel	562-3510
2	MX-Sensor	433 MHz	aluminum black	Autel	562-3510B
3	MX-Sensor	433 MHz	rubber	Autel	562-3511
4	1-Sensor	315/433 MHz	aluminum	Autel	562-3525
5	1-Sensor	315/433 MHz	aluminum black	Autel	562-3525B
6	1-Sensor	315/433 MHz	rubber	Autel	562-3526
7	Compact	315/433 MHz	aluminum	Mobiletron	562-3680
8	Compact	315/433 MHz	rubber	Mobiletron	562-3681
9	Compact	315/433 MHz	aluminum black	Mobiletron	562-3682

Valves for universal sensors

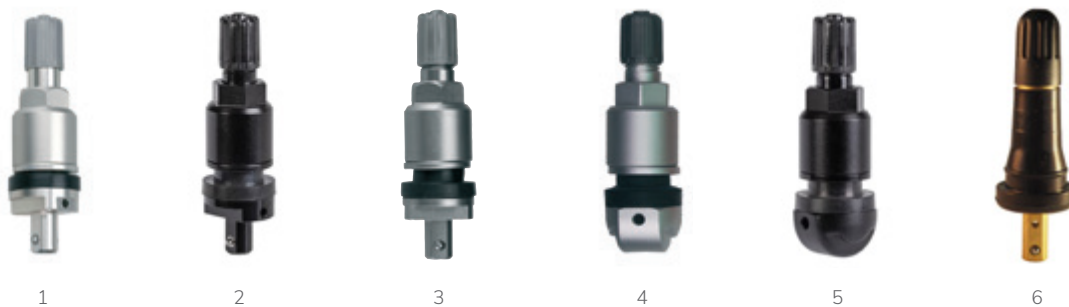

👁️	Description	Type of valve	Type of assembly	Color	Brand	Index
1	TPMS valve	aluminum	prees in	silver	Autel	562-3516
2	TPMS valve	aluminum	prees in	black	Autel	562-3516B
3	TPMS valve	aluminum	prees in	titan	Autel	562-3516T
4	TPMS valve	aluminum	screw in	silver	Autel	562-3517
5	TPMS valve	aluminum	screw in	black	Autel	562-3518
6	TPMS valve	rubber	prees in	black	Autel	562-3519
	Autel screw-in valve bolt kit				Autel	562-3517S

Valves for OEM sensors



1



2



3



4



5



6



7



8



9

👁	Description	Type of valve	Compatible with	Index
1	TPMS valve	rubber	OEM Schrader old type and EZ-Sensor	562-3904
2	TPMS valve	aluminum	OEM Schrader old type and EZ-Sensor	562-3908
3	TPMS valve	rubber	OEM Schrader new type and EZ-Sensor 2.0	562-3911
4	TPMS valve	aluminum	OEM Schrader new type and EZ-Sensor 2.0	562-3518A
5	TPMS valve	aluminum	OEM Schrader Alpha	562-3903
6	TPMS valve	aluminum	OEM Schrader Gamma i EZ-Sensor 2.0	562-3912
7	TPMS valve	aluminum	OEM Siemens/VDO T1GB	562-3901
8	TPMS valve	aluminum	OEM Conti/VDO TG1C	562-3907
9	TPMS valve	rubber	OEM Conti/VDO TG1D	562-3916

Valves for OEM sensors



Description	Type of valve	Compatible with	Index
1 TPMS valve	aluminum	OEM TRW	562-3910
2 TPMS valve	rubber	OEM TRW	562-3920
3 TPMS valve	rubber	OEM CUB	562-3919
4 TPMS valve	rubber	OEM Pacyfic	562-3926
5 TPMS valve	aluminum	OEM - Huf/Alligator	562-3906
6 TPMS valve chrome without screw	aluminum	OEM - Beru/Huf	562-3909
7 TPMS valve L=48 mm	aluminum	OEM - Beru/Huf	562-3913
8 TPMS valve L=56 mm	aluminum	OEM - Beru/Huf	562-3914
9 TPMS valve	aluminum	OEM - Beru/Huf	562-3902

Valves for truck



Description	Index
1 TPMS valve TRUCK	562-3915
2 TPMS valve TRUCK	562-3915W
3 TPMS valve TRUCK ALU	562-3921W
4 TPMS valve TRUCK L= 76 mm	562-3923W
5 TPMS valve TRUCK L= 73 mm	562-3925W

Repair kits for TPMS valves



1



2



3



4



5



6

 Description	Dedicated to	Index
1 Repair kit for TPMS Schrader Gen 2/3 valve for aluminum rims	Renault	562-3641
2 Repair kit for TPMS Schrader Gen 2/3 valve for aluminum rims	PSA / Fiat	562-3643
3 Repair kit for TPMS Schrader Gen 2/3 valve for aluminum rims	Nissan/Opel/Volvo	562-3644
4 Repair kit for TPMS Conti / VDO valve for aluminum rims	PSA	562-3645
Repair kit for TPMS Schrader Gen 2/3 valve for aluminum rims	Nissan/Infiniti/Renault	562-3647
Repair kit for TPMS Conti / VDO valve for aluminum rims	Ford	562-3661
Repair kit for TPMS valve for aluminum rims	Nissan	562-3662
Repair kit for TPMS valve for aluminum rims	Volvo	562-3663
5 Repair kit for TPMS Pacific LFB1/LFC1 valve for aluminum rims	Toyota/Lexus	562-3667
6 Set of gray TPMS caps - 25 pcs.		562-3666

Tyre mounting paste



The most frequently chosen pastes for tire mounting by vulcanizers. Provide excellent lubrication as well as quick and easy assembly and disassembly of all types of tires.



👁️	Description	Capacity	Consistency	Range temp.	Additional information	Index
	Tyre mounting paste Universal ECONOMY	1 kg	slightly creamy	0°C ÷ +30°C	Best price	593-0641
1	Tyre mounting paste Universal ECONOMY	3 kg	slightly creamy	0°C ÷ +30°C	Best price	593-0640
	Tyre mounting paste Universal ECONOMY	5 kg	slightly creamy	0°C ÷ +30°C	Best price	593-0642
2	Tyre mounting paste universal PREMIUM	5 kg	stiff	-15°C ÷ +30°C	Quick drying, invisible on the tire	593-0645
3	Tyre mounting paste universal BLACK	5 kg	stiff	-15°C ÷ +30°C	Invisible on the tire and rim	593-0646
4	Tyre mounting paste TRUCK ECONOMY	5 kg	stiff	-15°C ÷ +30°C	Long sliding distances with high friction between tyres and rims, extreme mounting conditions	593-0644

Tyre mounting ointment ACRYLMED



Ointments make removal and assembly of tyres simple. Application of ointments prevents damage during mounting and demounting of tyre.



👁️	Description	Capacity	Range temp.	Additional information	Index
1	ACRYLMED Red - tyre mounting ointment	4 kg	-10°C ÷ +30°C	Contains an additive sealant	DECZ4
2	ACRYLMED Blue - tyre mounting ointment	4 kg	-10°C ÷ +30°C	Recommended for use in sub-zero temperatures	DEN4
3	ACRYLMED Green - tyre mounting ointment	4 kg	-10°C ÷ +30°C	Universal	DEZ4

Mounting paste brushes



Vulcanizing brushes are intended for applying mounting paste to a tire and rim when installing tires. Specially profiled brush head facilitates the lubrication of the tire's bead across the entire rim without bending the hand. **Dense bristles do not deform and can last a long time.**



1



2



3

👁	Description	Head diameter	Visible length of bristle	Handle length	Total brush length	Index
1	Special brush for car tyres	ø 30 mm	45 mm	230 mm	275 mm	593-0580
2	Special brush for car tyres	ø 40 mm	45 mm	230 mm	280 mm	593-0584
3	Special brush for truck tyres	ø 55 mm	51 mm	230 mm	290 mm	593-0618

Talcum powder

Technical talc is irreplaceable during the assembly of inner tubes in the tire. Guarantees an even distribution of the inner tube of the tire, prevents it from „sticking“ to the tire during pumping. Effectively prevents the sticking of the rubber. Possibility to buy the white or gray talcum **in white packages (without label), when ordering specified MOQ.**



1



2



3

👁	Description	Weight	Index
1	White talcum, INVENTO label	400 g	593-0651
2	White talcum, bag	25 kg	593-0687
3	Gray talcum (no label, MOQ: 1 200 pcs)	500 g	EXP593-0649
	White talcum (no label, MOQ: 1 200 pcs)	400 g	EXP593-0651

Bead Sealer



Bead Sealer provides an airtight seal between the rim edge and the tire bead.



1



2

👁	Description	Capacity	Consistency	Index
1	BEAD SEALER INVENTO	1 l	elastic, dense	593-0900
2	BEAD SEALER DELTA EXTRA	0,945 l	elastic, dense	DEBS-EXTRA

Tyre Sealant



Preventative all-purpose sealant for tube and tubeless tires of all sizes. It **seals damages up to 6 mm** and prevents corrosion of wheel and conditions the tire inner liner. The product can stay in the tire indefinitely, helping to prevent tire and tube rot. Proven, homogenous formula, glycol free. **Freeze point: -23°C.**



1



2

👁	Description	Capacity	Additional information	Index
3	STS Tyre Sealant	20 l	seals damage up to 6 mm without removing the tire from the vehicle wheel. It allows to perform a full-fledged repair of the sealed tire and continue driving	566-0500
4	Tyre Seal Pump	-	precisely doses the measured amount of product for each tire size	566-0505

Black Tyre Paint, Concentrate

Specially formulated black paint for improved appearance, coverage and tyre adhesion. **Gives retread and used tyres a like-new, black satin or mat finish. Completely covers crayon marks and dirt.** Dries quickly. **Economical concentrate formula** dilutes with water and saves material cost, storage space and shipping expense. Available in a concentrated form.



1



2



3



4

👁	Description	Capacity	Consistency	Index
1	ECO BLACK Tyre Paint Concentrate	1 l	concentrate	593-5053A
2	ECO BLACK Tyre Paint Concentrate	5 l	concentrate	593-5054A
3	TOAL MIX EXTRA MAT Tyre Paint Concentrate	1 l	concentrate	DETM-EXTRAMAT
4	TOAL MIX EXTRA MAT Tyre Paint Concentrate	5 l	concentrate	DETM-EXTRAMAT-5

Tyre bags

Dedicated to the storage of tires after seasonal replacement. They are made of thick and strong LDPE plastic and reinforced with a durable weld. Resistant to damage and accidental tearing.



👁	Description		Size	Package	Foil thickness	Index
1	ECO Tyre bag	ECONOMY	1100 x 1000 mm	10 pcs. roll	30 µm	583-1100-ECO
2	PROFI L size Tyre bag	PREMIUM	1000 x 1000 mm	100 pcs. pack	40 µm	583-1000-PROFI
3	PROFI XL size Tyre bag	PREMIUM	1200 x 1200 mm	100 pcs. pack	40 µm	583-1200-PROFI

Tyre chalks

For permanent marking or to describe the place of damage in tires and marking of tires during seasonal tire changes. Highly effective when used on any surface including rubber, metal and paint.



👁	Description		Diameter	Length	Quantity	Index
1	White chalk - round, TIP-TOPOL		13 mm	95 mm	12 pcs.	595-8471
2	Yellow chalk - round, TIP-TOPOL		13 mm	95 mm	12 pcs.	595-8472
3	Red chalk - round, TIP-TOPOL		13 mm	95 mm	12 pcs.	595-8477
4	White chalk, PROFI		13 mm	120 mm	12 pcs.	595-8540
5	Yellow chalk, PROFI		13 mm	120 mm	12 pcs.	595-8550
6	Red chalk, PROFI		13 mm	120 mm	12 pcs.	595-8560
7	White chalk thick, PROFI		17 mm	90 mm	12 pcs.	595-8510
8	Yellow chalk thick, PROFI		17 mm	90 mm	12 pcs.	595-8520
9	White chalk thick, SISA	PREMIUM	17 mm	90 mm	12 pcs.	595-0131
10	Yellow chalk thick, SISA	PREMIUM	17 mm	90 mm	12 pcs.	595-0203
11	Chalk holder SISA, plastic		16-17 mm	90 mm	1 pcs.	595-0227
12	Chalk holder, aluminum		16-19 mm	110 mm	1 pcs.	595-8530

Hand cleaners

High-quality preparations for thorough removal of grease, oil, technical fluids, dust, gasoline, etc. from the hands. Dermatologically tested products. Do not contain sand.



👁	Description	Capacity	Consistency	Color	Index
1	STRONG hand cleaner	0,5 l	stiff	pink	593-2010
2	STRONG hand cleaner	5 l	stiff	pink	593-2020
3	STRONG hand cleaner	10 l	stiff	pink	593-2030
4	STRONG hand cleaner	0,5 l	semi - liquid	blue	593-2024
5	STRONG hand cleaner	4 l	semi - liquid	blue	593-2021
6	STRONG hand cleaner	5 l	semi - liquid	blue	593-2040
7	STRONG paste dispenser 4 l				593-2022
8	STRONG paste hanger 4 l				593-2023

Cans and brushes

The brushes, thanks to the appropriate length, ensure full use of the glue from the can, and the cap with the seal protects the glue or sealant against air.



👁	Description	Capacity	Index
1	Can, nut and brush	650 g	595-4820
2	Can 250 ml and nut	250 ml	KON000-0002
3	Glue brush 240 mm length, fits 595-8346 nut		595-8308
4	Glue brush for can 250ml		595-8353
5	Can nut		595-8346

Probes and cutters

Inserting tools are used to pull butyl vulcanization cords in a tire in the process of emergency repair. They have a contoured handle, ensuring comfortable positioning of the tool in the hand during work. Cutters are used to remove rubber residues from damaged places on the target cleaning the hole resulting from tire damage and preparing the damage for repair with a cord.

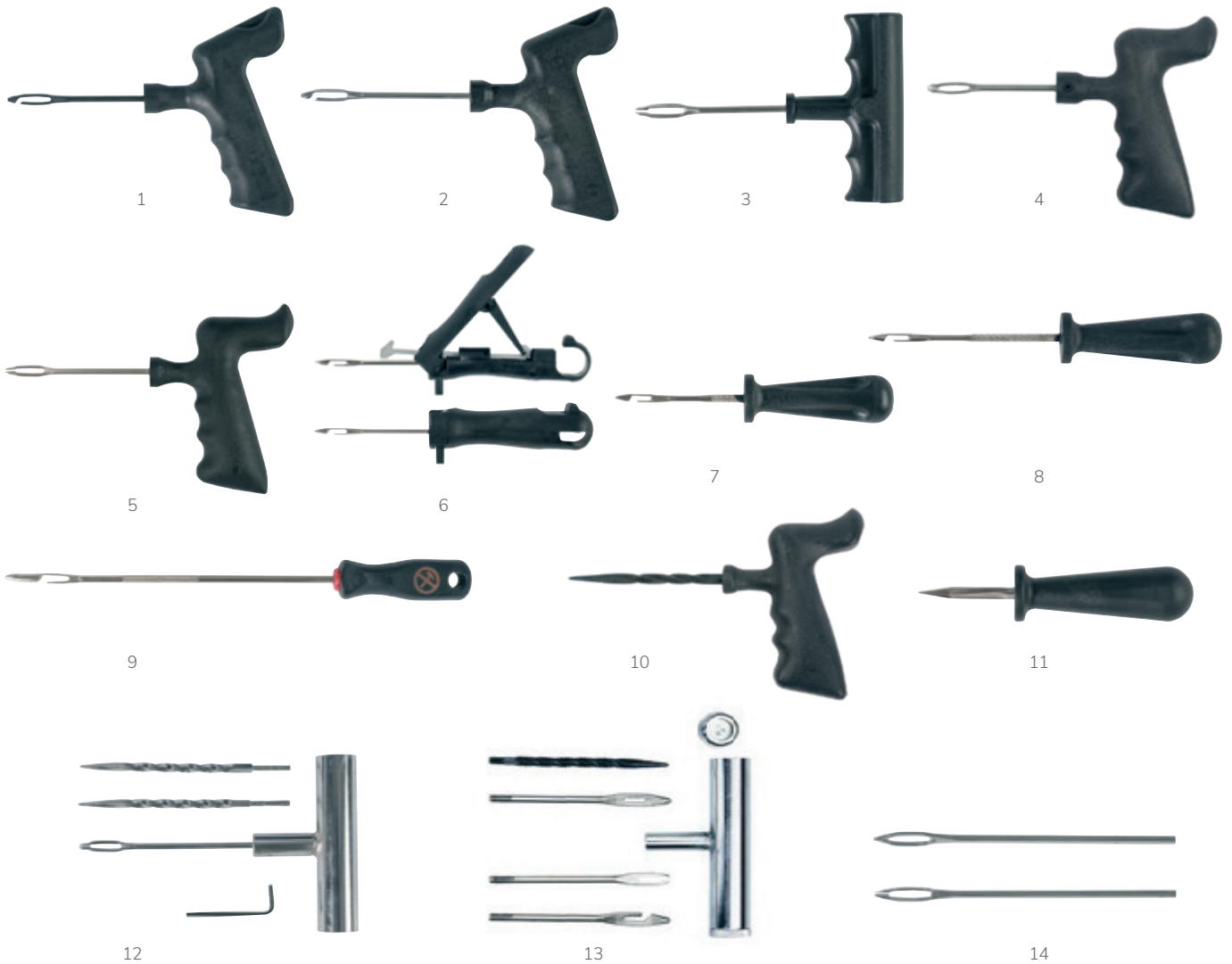

👁	Description	Holder type	Length	Index
1	Plastic pistol-grip handle inserting tool with open-eye needle	pistol-grip	75 mm	510-1526
2	Plastic pistol-grip handle inserting tool with open-eye needle	pistol-grip	90 mm	510-1533
3	Plastic T-handle inserting tool with split-eye needle	T- handle	75 mm	510-1818
4	Tyre inserting tool	pistol-grip	75 mm	510-1819
5	Tyre inserting tool	pistol-grip	95 mm	510-1822
6	Inserting tool with folding handle	folding handle	75 mm	510-2202
7	Tyre inserting tool	straight	72 mm	510-2219
8	Tyre inserting tool	straight	96 mm	510-2226
9	Tyre inserting tool	straight	230 mm	510-2233
10	Spiral cutter	pistol-grip	98 mm	510-1823
11	Hand cutter 6 mm	straight	45 mm	510-2240
12	3-in-1 T-Handle tool (open-eye needle, 2 cutters, L wrench)	T- handle	105 mm	510-2415
13	4-in-1 Needle set (3x insertion tool, cutter)	T- handle	105 mm	510-2420
14	Replaceable needles 130 mm		130 mm	510-2421

Butyl tyre repair inserts

Intended for temporary tread puncture repair on radial and diagonal tubeless tires without the need for removing the tire from the rim.



1



2



3



4



5



6

👁	Description	Length	Diameter	Application	Tyre type	Quantity	Index
1	Radial string PKW, brown	102 mm	6 mm	passenger cars	radial / diagonal	50 pcs.	510-1801
2	Radial string LKW, brown	204 mm	8 mm	trucks	radial / diagonal	25 pcs.	510-1863
3	Radial string PKW, black	184 mm	5 mm	passenger cars	radial / diagonal	50 pcs.	510-1864
4	Radial tire repair kit	102 mm	6 mm	passenger cars	radial / diagonal	set, 5 pcs.	510-1867
5	Passenger tire repair kit	102 mm	6 mm	passenger cars	radial / diagonal	set, 50 pcs.	510-1865
6	Truck tire repair kit	204 mm	8 mm	trucks	radial / diagonal	set, 25 pcs.	510-1866

Rubber rope extruders

Designed for quick filling of funnels, damages and losses of rubber in all types of tires.



1



2



3



4

👁	Description	Capacity	Heater	Power	Working pressure	Index
1	Extruder "Tubeless 2" 220V + 5 nozzles	6 kg/h	350 W 220V/110V	400 W	5-8 bar	517-7608 SALV
2	Extruder Standard SALVADORI	18 kg/h	350 W 220V/110V	750 W	5-8 bar	517-7505 SALV
3	Extruder Standard BOSCH	18 kg/h	350 W 220V/110V	550 W	5-8 bar	517-7505
4	Extruder MAGNUM BOSCH	24 kg/h	350 W 220V/110V	550 W	5-8 bar	517-4948

Carbide cutters HARTMETAL

Highly durable cutters for precise injury preparation on radial and cross-ply tyres. Special profile adapted to steel cord preparation allows professional grinding out of the injury. Intended to use when repairing with the repair unit Minicombi or Remastem.



👁	Description	Diameter	Blade length	Total length	Speed	Arbour for hand drill	Arbour for quick release chuck	Arbour MK 1 for flexible shaft	Index
1	HM cutter	Ø 3 mm	25 mm	50 mm	25 000 rpm	3 mm	519-6782	595-4027 + 519-6782	595-4900
2	HM cutter	Ø 4,5 mm	30 mm	90 mm	2 500 rpm	6 mm	519-6672	595-0519	595-5019
3	HM cutter	Ø 6 mm	25 mm	65 mm	25 000 rpm	6 mm	519-6672	595-0519	595-4924
4	HM cutter	Ø 6 mm	25 mm	65 mm	25 000 rpm	6 mm	519-6673	595-0520	595-4931**
5	HM cutter	Ø 6 mm	50 mm	90 mm	2 500 rpm	6 mm	519-6672	595-0519	595-4962
6	HM cutter	Ø 8 mm	50 mm	100 mm	2 500 rpm	8 mm	519-6689	595-4278	595-4948
7	HM cutter	Ø 10 mm	60 mm	110 mm	2 500 rpm	10 mm	519-6593	595-4027+519-6593	595-5060
8	HM cutter	Ø 12 mm	60 mm	120 mm	2 500 rpm	10 mm	519-6593	595-4027+519-6593	595-5040
9	HM cutter	Ø 20 mm	-	-	25 000 rpm	6 mm	519-6672	595-0519	595-4955**

Cutters HM – ECO

Designed for injury preparation on radial and cross-ply tyres, allows professional grinding out of the injury. **Packed separately in a plastic box.**



👁	Description	Diameter	Blade length	Total length	Speed	Arbour for hand drill	Arbour for quick release chuck	Arbour MK 1 for flexible shaft	Index
1	HM - ECO Cutter	Ø 3 mm	30 mm	60 mm	2 500 rpm	3 mm	519-6782	595-4027 +519-6782	511-1330
2	HM - ECO Cutter	Ø 4,5 mm	50 mm	80 mm	2 500 rpm	4,5 mm	519-6672	595-0519	511-1345
3	HM - ECO Cutter	Ø 6 mm	55 mm	90 mm	2 500 rpm	6 mm	519-6672	595-0519	511-1360
4	HM - ECO Cutter	Ø 8 mm	60 mm	105 mm	2 500 rpm	8 mm	519-6689	595-4278	511-1380
5	HM - ECO Cutter	Ø 10 mm	65 mm	110 mm	2 500 rpm	10 mm	519-6593	595-4027 +519-6593	511-1310
6	HM - ECO Cutter	Ø 12 mm	70 mm	110 mm	2 500 rpm	12 mm	519-6593	595-4027 +519-6593	511-1320

** on request

Ball shaped chip rasps

Ball shaped chip rasps



Description	Diameter	Granulation	Tool hangers		Index
			Hand drill	Quick release chuck	
1 Ball	Ø 19 mm	K18	6 mm	519-6672	595-8920
2 Ball	Ø 20 mm	K330	6 mm	519-6672	595-4371

Domed contour rasps



Description	Size	Granulation	Thread	Tool hangers		Index
				Hand drill	Quick release chuck	
1 Dome rasp	32 x 18 mm	K170	3/8"	595-4034	519-6610	595-4735
2 Dome rasp	44 x 19 mm	K170	3/8"	595-4034	519-6610	595-4632
Dome rasp	50 x 25 mm	K18	3/8"	595-4034	519-6610	595-6056
3 Dome rasp	50 x 25 mm	K18	3/8"	595-4034	519-6610	595-8865
Dome rasp	50 x 25 mm	K23	3/8"	595-4034	519-6610	IT205-0110
Dome rasp	50 x 25 mm	K36	3/8"	595-4034	519-6610	595-8975
Dome rasp	65 x 15 mm	K46	3/8"	595-4034	519-6627	595-4216
Dome rasp	65 x 25 mm	K170	3/8"	595-4034	519-6610	595-4357
Dome rasp	76 x 32 mm	K36	14 mm	595-4261	519-6634	595-4209
4 Dome rasp	76 x 32 mm	K18	14 mm	595-4261	519-6634	595-4223
Dome rasp	76 x 32 mm	K390/16	3/8"	595-4034	519-6610	SALV-C116
5 Dome rasp	102 mm	K18	14 mm	595-4261	519-6634	595-4247**

Buffing wheels



Description	Size	Granulation	Thread	Tool hangers		Index
				Hand drill	Quick release chuck	
1 Buffing wheel	35 x 3,5 mm	K36 / K230		6 mm	519-6672	595-4340
2 Buffing wheel	50 x 3 mm	K18		6 mm	519-6672	595-8786
3 Buffing wheel	50 x 3,5 mm	K18	thread 3/8"	595-4034	519-6610	IT205-0140
Buffing wheel	50 x 5 mm	K18	thread 3/8"	595-4034	519-6610	IT205-0141
4 Buffing wheel	50 x 10 mm	K18	thread 3/8"	595-4034	519-6610	595-8858
4 Buffing wheel	50 x 10 mm	K18	thread 3/8"	595-4034	519-6610	IT205-0143
Buffing wheel	50 x 13 mm	K18	thread 3/8"	595-4034	519-6610	595-4388**
Buffing wheel	76 x 16 mm	K18	hole 14 mm	595-4261	519-6634	595-8834**
Buffing wheel	102 x 19 mm	K18	hole 14 mm	595-4261	519-6634	595-8841**

** on request

Chip cones



Description	Diameter	Length	Granulation	Speed	Tool hangers		Index
					Hand drill	Quick release chuck	
1 Pencil buffer	5-8 mm	105 mm	K18	4 500 rpm	6 mm	519-6672	595-8906
2 Pencil buffer	8 mm	170 mm	K18	4 500 rpm	8 mm	519-6689	595-8968
3 Cone buffer, thread 3/4"	25 mm	50 mm	K18	4 500 rpm	595-4034	519-6610	595-8872
4 Cone buffer, thread 3/4"	25 mm	102 mm	K18	4 500 rpm	595-4034	519-6610	595-0739

Grinding tools



Description	Shape	Size	Tool hangers		Index
			Hand drill	Quick release chuck	
1 Stone	ring	30 x 6 mm	6 mm	519-6672	IT208-0290
Stone	ring	32 x 6 mm	6 mm	519-6672	595-4412
2 Stone	ring	35 x 8 mm	6 mm	519-6672	IT208-0291
Stone	ring	40 x 10 mm	6 mm	519-6672	595-0650**
Stone	ring	50 x 10 mm	6 mm	519-6672	595-4797**
3 Stone	cone	7 x 25 mm	6 mm	519-6672	595-4405
Stone	cone	14 x 45 mm	6 mm	519-6672	595-4810
Stone	cone	20 x 65 mm	6 mm	519-6672	595-0629
4 Stone	ball	Ø 20 mm	6 mm	519-6672	595-0681
Stone, pink, K60	ring	Ø 35 mm	6 mm	519-6672	SALV-0373R
Stone, pink, K60	ring	Ø 50 mm	6 mm	519-6672	SALV-0353R
5 Stone, hole 16 mm	ball	75 x 7 mm	-	595-0674/519-6689	IT208-0286
Buffing ball - pumice stone	ball	Ø 40 mm	6 mm	519-6672	595-0083

Rasping kit for small repairs



The tools are a set enabling the treatment of damages in passenger and delivery tires in all zones.



Description	Size	Granulation	Tool hangers		Index
			Hand drill	Quick release chuck	
1 Rasping kit, 4 elements	25 x 3 mm	K60	3 mm	519-6782	595-4711

** on request

Rotary wire brushes

Steel brushes are designed **to rasp rubber** with max. rotary speed **2 800 rpm**. The perfect solution for the careful treatment of rubberized steel cord to achieve an optimal buffing texture in the truck tires, steel and textile cords in diagonal tube agriculture tyres.



Description	Size	Hole	Tool hangers		Index
			Hand drill	Quick release chuck	
1 Steel rotary brush, contour embedded in PCV	50 x 7 mm	3/8"	595-4034	519-6627	595-4522
2 Steel rotary brush, contour embedded in PCV	50 x 7 mm	3/8"	595-4034	519-6627	595-4522CZ
3 Steel rotary brush, contour embedded in PCV	76 x 8 mm	14 mm	595-4261	519-6634	595-4168
4 Steel rotary brush, contour embedded in PCV	76 x 20 mm	14 mm	595-0533	519-6665	595-4175
5 Brass-coated steel rotary brush	55 x 8 mm		6 mm	519-6672	595-0722
6 Steel rotary brush	60 x 20 mm		6 mm	519-6672	595-0076
7 Spiral/pencil brush for the repair of very small injuries	8 x 25 mm		6 mm	519-6672	595-4560

Finish buffer ES

Finish buffers are designed to remove bleeds when doing cosmetic treatment of vulcanized places. Rotational speed: **max. 2 800 rpm**.

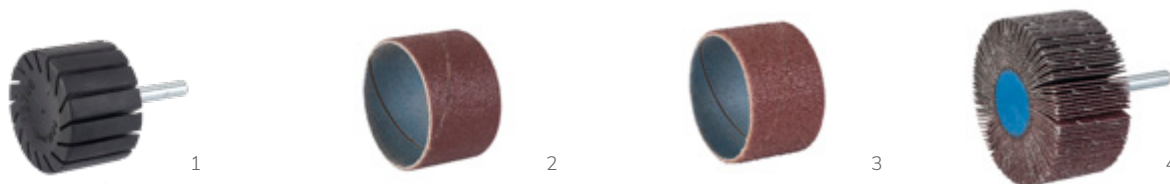

Description	Size	Granulation	Tool hangers		Index
			Hand drill	Quick release chuck	
1 Finish buffer kit ES	45 x 30 mm		6 mm	519-6672	595-5507
2 Paper for a roller ES	45 x 30 mm	K60	-	-	595-5514
3 Paper for a roller ES	45 x 30 mm	K40	-	-	595-5521
4 Flap wheel	60 x 30 mm	K80	6 mm	519-6672	594-0830

Rotary gouges

Rotary gouges are designed to remove rubber from damaged places from all types of tyres. Rotational max speed **4 500 rpm**.

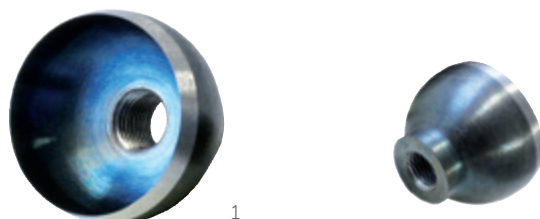

Description	Size	Tool hangers		Index
		Hand drill	Quick release chuck	
1 Rotary gouge	50 mm	595-4034	519-6610	595-4292
2 Rotary gouge mini	30 mm	595-4034	519-6610	595-4326

Arbours - adapters for quick release chuck type, hexagonal

The holders enable the tool to be mounted in the device appropriate for the RPM Ranges. Designed for tools with a handle hexagonal, e.g. INVENTO PX87 grinder.



👁	Description	Size	Application	Index
	Tool holder 6K/3	hole 3 mm	tools with 3 mm shaft	519-6782
1	Tool holder 6K/6	hole 6 mm	tools with 6 mm shaft	519-6672
	Tool holder 6K/8	hole 8 mm	tools with 8 mm shaft	519-6689
	Tool holder 6K/10	hole 10 mm	tools with 10 mm shaft	519-6593**
2	Adapters for quick release chuck type 3/8"-24	thread 3/8" x 12 mm	thread tool or holes 3/8"	519-6610
	Arbour NV 11	thread 3/8" x 21 mm	brush 595-4522, grinding wheel 595-4216	519-6627
3	Adapters - quick release chuck MV11 M14	thread M14 x 11 mm	tools with 14 mm bore and clamping height max. 4 mm	519-6634
4	Tool holder M14	thread M14	brush 595-4175	519-6665

Arbours - adapters for quick release chuck type, cylindrical

The grips enable the tool to be mounted in the device with the appropriate range of revolutions. Suitable for tools with a drill holder.



👁	Description	Diameter	Application	Index
1	Tool grip	6 mm	Buffing tools with 3/8" thread	595-3932
2	Tool grip	8 mm	Brush 595-4175	595-0533
3	Tool grip	8 mm	Buffing tools with 3/8" thread	595-4034
4	Tool grip	8 mm	Buffing tools with M14 bore	595-4261

Stitchers

Pressure rollers enable **mechanical pressure** adjusted to a type of applied material - feed, blend, patch during repair of tires or inner tubes.



👁	Description	Width	Diameter	Index
1	Stitcher with a bearing	4 mm	35 mm	595-1044
2	Stitcher with a bearing	12 mm	35 mm	595-1123
3	Stitcher with a wooden holder	4 mm	35 mm	596-1027
4	Needle roller	46 mm	52 mm	IT209-0313

** on request

Whetstone and knives



👁	Description	Index
1	Special knife for removal of original DOT/serial numbers	519-7120
2	Rubber knife, 125 mm	595-2074**
3	Overflow cutter simple	519-7073**
4	Rubber knife, 130 mm	595-2036
5	Whetstone	595-2225
6	Whetstone with wooden holder	595-2153**

Accessory tools for tyre repair

Scraper enables initial cleaning of tires from the inside and the outside. Apply Liquid Buffer on area subject of cleaning. The picks are helpful when inspecting damage before and after treatment.



👁	Description	Index
1	Skewer wooden handle	570-9270
2	Scraper	595-1178
3	Scraper for profiled inner liners	595-4515
4	Side cutter for steel cord	595-0801

Brushes and Vacuum Cleaner

The coconut fiber brush allows you to safely remove rubber grit from the tire on rough surfaces. Wooden handle is filled with coconut fiber, which is characterized by resistance to deformation, bending and spreading, even during intensive use. In combination with a vacuum cleaner, it completely removes the dust left after roughing. With a vacuum cleaner without a textile bag, it is also possible to remove water from the tires.



👁	Description	Index
1	Brass-bristled brush	595-4553
2	Coconut bristle brush	594-0000
3	Vacuum cleaner	519-0057

** on request

Tyre regroovers

Designed for regrooving all tread patterns on commercial vehicles tyres and to re-new it after the repair of a tire. Replaceable knives, both circular and angular, enable making cuts 3 to 28 mm wide.



1



3



2

 Description	Additional information	Index
1 Tyre regroover PREMA CUTTER 300	4-step switch to adjust the power, convenient handle for carrying	PA242-1002
2 Tyre regroover PS15	4 levels of temperature regulation, cable 170 cm long, max. power: 370 W	AT000-1500
3 Tyre regroover PS15 OTR	5 levels of temperature regulation, cable 170 cm long, max. power: 1 000 W	AT000-1520

Regroover blades PREMA CUTTER

 Description	Size	Quantity	Index
R Fix 1	3 - 4 mm	20 pcs.	PA242-1005
R Fix 2	5 - 6 mm	20 pcs.	PA242-1010
1 R Fix 3	6 - 8 mm	20 pcs.	PA242-1015
R Fix 5	10 - 14 mm	20 pcs.	PA242-1025
W Fix 1	3 - 4 mm	20 pcs.	PA242-1050
W Fix 2	5 - 6 mm	20 pcs.	PA242-1055
W Fix 3	6 - 8 mm	20 pcs.	PA242-1060
W Fix 4	9 - 10 mm	20 pcs.	PA242-1061
W Fix 5	10 - 14 mm	20 pcs.	PA242-1065
W Fix 6	22 - 28 mm	10 pcs.	PA242-1070



1

Regroover blades PS 15

 Description	Size	Quantity	Index
R - 1	3 - 5 mm	20 pcs.	AT000-1501
R - 2	5 - 11 mm	20 pcs.	AT000-1502
1 R - 3	7 - 13 mm	20 pcs.	AT000-1503
R - 4	10 - 14 mm	20 pcs.	AT000-1504
R - 5	11 - 18 mm	20 pcs.	AT000-1505
C - 1	3 - 5 mm	20 pcs.	AT000-1506
C - 2	6 - 10 mm	20 pcs.	AT000-1507
C - 3	8 - 12 mm	20 pcs.	AT000-1508
C - 4	10 - 14 mm	20 pcs.	AT000-1509
C - 5	12 - 17 mm	20 pcs.	AT000-1510
C - 6	20 - 28 mm	10 pcs.	AT000-1511



1

Connection system

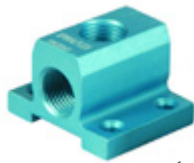

1



2



3

👁	Description	Size	Index
1	Connection system	3 x 1/2"	PNLISTW-3201
2	Connection system	4 x 1/2"	PNLISTW-3202
3	Connection system	5 x 1/2"	PNLISTW-3203

Air preparation components

Max. inlet pressure: 16 bar. The accuracy of the filtration of our oil filters is 40 µm.



1



2



3



4

👁	Description	Flow rate	Size	Index
1	Initial filter OF MIDI RQS	3 000 l/min	1/2"	PNRCOF1/2MIDI
2	Filter integrated with the reducer OFR MIDI RQS	3 400 l/min	1/2"	PNRCOFR1/2MIDI
3	Air lubricator OL MIDI RQS	6 100 l/min	1/2"	PNRCOL1/2MIDI
4	Air preparation block OU MIDI RQS	2 600 l/min	1/2"	PNFROU12MIDI

Accessories and installation components



1



2



3



4

👁	Description	Size	Index
1	Grease Gun	1/4"	PNCN204-L00
2	Plastic clamp	15 mm	PNJG-RK15**
	Plastic clamp	18 mm	PNJG-RK18**
	Plastic clamp	22 mm	PNJG-RK22**
3	Release aid	15 mm	PNCM1815S**
	Release aid	18 mm	PNCM1818S**
	Release aid	22 mm	PNCM1822S**
4	Module FRM	1/2"	PNRFRM12MIDI**
	Connecting bold FRM (2 pcs.)	1/2"	PNRCNB2MIDI**

** on request

Air hoses



1



2



3

👁	Description	Color	Temperature Range	Outside diameter	Inside diameter	Working Pressure	Index
1	PVC air hose	transparent	-5°C - +30°C	10 mm	6 mm	21 bar	PNP6
	PVC air hose	transparent	-5°C - +30°C	12 mm	8 mm	19 bar	PNP8
	PVC air hose	transparent	-5°C - +30°C	14 mm	10 mm	17 bar	PNP10
	PVC air hose	transparent	-5°C - +30°C	17,5 mm	12,5 mm	16 bar	PNP12**
2	PVC air hose	light blue	-10°C - +60°C	13 mm	8 mm	25 bar	PNPAZ-0813
	PVC air hose	light blue	-10°C - +60°C	15 mm	10 mm	25 bar	PNPAZ-1015
	PVC air hose	light blue	-10°C - +60°C	19 mm	13 mm	25 bar	PNPAZ-1319
3	PA air hose	blue	-60°C - +100°C	15 mm	12 mm	15 bar	PNRAT-1512
	PA air hose	blue	-60°C - +100°C	18 mm	14 mm	16 bar	PNRAT-1815
	PA air hose	blue	-60°C - +100°C	22 mm	18 mm	14 bar	PNRAT-2218

Air hose reels and polyurethane coiled hoses

Closed composi.



1



2



3

👁	Description	Length	Input/output	Outside diameter	Inside diameter	Working Pressure	Index
1	Hose reel RQS range 705	8 m	1/4" male thread	12 mm	8 mm	12 bar	PNRZRE705083**
2	Hose reel RQS range 730	15 m	3/8" male thread	14,5 mm	10 mm	12 bar	PNRZRE735153**
	Polyurethane coiled hose assembly, blue	5 m		12 mm	8 mm	10 bar	PNW12805
3	Polyurethane coiled hose assembly, blue	10 m		12 mm	8 mm	10 bar	PNW12810
	Polyurethane coiled hose assembly, blue	15 m		12 mm	8 mm	10 bar	PNW12815
	Polyurethane coiled hose assembly, blue	5 m		12 mm	8 mm	10 bar	PNWR1285
	Polyurethane coiled hose assembly, blue	9 m		12 mm	8 mm	10 bar	PNWR12810
	Polyurethane coiled hose assembly, blue	15 m		12 mm	8 mm	10 bar	PNWR12815
	Polyurethane coiled hose assembly, blue	15 m		16 mm	11 mm	10 bar	PNWR1611151727KA**

Couplings Type Y



1



2

👁	Description	Size	Thread Type	Index
1	Two-way coupler	1/2"	female thread	PNDWOJ
2	Three-way coupler	1/2"	female thread	PNTROJ

** on request

Brass couplings, type 26KA



Capacity: 960 l/min. Working pressure: 35 bar.



👁	Description	Size	Thread Type	Index
1	Coupling RECTUS Typ 26KA	1/4"	female thread	PNRS14W26
	Coupling RECTUS Typ 26KA	3/8"	female thread	PNRS38W26
	Coupling RECTUS Typ 26KA	1/2"	female thread	PNRS12W26
2	Coupling RECTUS Typ 26KA	1/4"	male thread	PNRS14Z26
	Coupling RECTUS Typ 26KA	3/8"	male thread	PNRS38Z26
	Coupling RECTUS Typ 26KA	1/2"	male thread	PNRS12Z26
	Coupling RECTUS Typ 26KA	6 mm	hose tailpiece	PNRS626
3	Coupling RECTUS Typ 26KA	8 mm	hose tailpiece	PNRS826
	Coupling RECTUS Typ 26KA	9 mm	hose tailpiece	PNRS926
	Coupling RECTUS Typ 26KA	10 mm	hose tailpiece	PNRS1026
4	Coupling RECTUS Typ 26KA	13 mm	hose tailpiece	PNRS1326
	Coupling RECTUS Typ 26KA	12x8 mm	with spring guard	PNRS12826

Brass adaptors, type 26 KA



Capacity: 960 l/min. Working pressure: 35 bar.



👁	Description	Size	Thread Type	Index
1	Adaptor RECTUS type 26KA	1/4"	female thread	PNRK14W26
	Adaptor RECTUS type 26KA	3/8"	female thread	PNRK38W26
	Adaptor RECTUS type 26KA	1/2"	female thread	PNRK12W26
2	Adaptor RECTUS type 26KA	1/4"	male thread	PNRK14Z26
	Adaptor RECTUS type 26KA	3/8"	male thread	PNRK38Z26
	Adaptor RECTUS type 26KA	1/2"	male thread	PNRK12Z26KA
	Adaptor RECTUS type 26KA	9 mm	hose tailpiece	PNRK926
3	Adaptor RECTUS type 26KA	10 mm	hose tailpiece	PNRK1026
	Adaptor RECTUS type 26KA	13 mm	hose tailpiece	PNRK1326
	Adaptor RECTUS type 26KA	12x8 mm	with spring guard	PNRK12826

Couplings and adaptors, type 1625



Capacity: 2020 l/min. Working pressure: 35 bar.



👁	Description	Size	Thread Type	Index
1	Coupling RECTUS, type 1625KA	1/2"	female thread	PNRS12W1625
2	Coupling RECTUS, type 1625KA	1/2"	male thread	PNRS12Z1625
	Coupling RECTUS, type 1625KA	9 mm	hose tailpiece	PNRS91625
3	Coupling RECTUS, type 1625KA	10 mm	hose tailpiece	PNRS101625
	Coupling RECTUS, type 1625KA	13 mm	hose tailpiece	PNRS131625
	Adaptor RECTUS, type 1625KA	3/8"	male thread	PNRK38Z1625
4	Adaptor RECTUS, type 1625KA	1/2"	male thread	PNRK12Z25KA
	Adaptor RECTUS, type 1625KA	9 mm	hose tailpiece	PNRK925KA
	Adaptor RECTUS, type 1625KA	10 mm	hose tailpiece	PNRK1025KA
5	Adaptor RECTUS, type 1625KA	13 mm	hose tailpiece	PNRK1325KA

Couplings and adaptors, type 1727



Capacity: 3500 l/min. Working pressure: 35 bar.



👁	Description	Size	Thread Type	Index
1	Coupling RECTUS, type 1727	1/2"	female thread	PNRS12W1727
2	Coupling RECTUS, type 1727	1/2"	male thread	PNRS12Z1727
3	Coupling RECTUS, type 1727	10 mm	hose tailpiece	PNRS101727
	Coupling RECTUS, type 1727	13 mm	hose tailpiece	PNRS131727
	Coupling RECTUS, type 1727	16 mm	hose tailpiece	PNRS161727
4	Adaptor RECTUS, type 1727KA	1/2"	male thread	PNRK12Z1727
	Adaptor RECTUS, type 1727KA	10 mm	hose tailpiece	PNRK101727
	Adaptor RECTUS, type 1727KA	13 mm	hose tailpiece	PNRK131727
5	Adaptor RECTUS, type 1727KA	16 mm	hose tailpiece	PNRK161727

Hardened steel construction couplings



Capacity: 2 200 l/min.



👁	Description	Size	Thread Type	Indeks
1	Coupling PCL	1/4"	female thread	PNPCLAC7-1CF
	Coupling PCL	3/8"	female thread	PNPCLAC7-1EF
	Coupling PCL	1/2"	female thread	PNPCLAC7-1JF
2	Coupling PCL	1/4"	male thread	PNPCLAC7-1CM
	Coupling PCL	3/8"	male thread	PNPCLAC7-1EM
	Coupling PCL	1/2"	male thread	PNPCLAC7-1JM
	Coupling PCL	6 mm	hose tailpiece	PNPCLAC7-106
	Coupling PCL	8 mm	hose tailpiece	PNPCLAC7-108
3	Coupling PCL	10 mm	hose tailpiece	PNPCLAC7-110
	Coupling PCL	13 mm	hose tailpiece	PNPCLAC7-113

Hardened steel construction adaptors



Capacity: 2 200 l/min.



👁	Description	Size	Thread Type	Indeks
1	Adaptor PCL	1/4"	female thread	PNPCLAA7-106
	Adaptor PCL	3/8"	female thread	PNPCLAA7-107
	Adaptor PCL	1/2"	female thread	PNPCLAA7-108
2	Adaptor PCL	1/4"	male thread	PNPCLAA7-102
	Adaptor PCL	3/8"	male thread	PNPCLAA7-103
	Adaptor PCL	1/2"	male thread	PNPCLAA7-104
	Adaptor PCL	6 mm	hose tailpiece	PNPCLAA7-110
	Adaptor PCL	8 mm	hose tailpiece	PNPCLAA7-111
3	Adaptor PCL	10 mm	hose tailpiece	PNPCLAA7-112
	Adaptor PCL	13 mm	hose tailpiece	PNPCLAA7-113

Quick safety couplings



Capacity: 1 820 l/min.



1



2



3

👁	Description	Size	Thread Type	Index
1	Coupling PREVOST	1/4"	female thread	PNAESI071101
	Coupling PREVOST	3/8"	female thread	PNAESI071102
	Coupling PREVOST	1/2"	female thread	PNAESI071103
2	Coupling PREVOST	1/4"	male thread	PNAESI071151
	Coupling PREVOST	3/8"	male thread	PNAESI071152
	Coupling PREVOST	1/2"	male thread	PNAESI071153
3	Coupling PREVOST	9 mm	hose tailpiece	PNAESI071809
	Coupling PREVOST	13 mm	hose tailpiece	PNAESI071813

Quick safety adaptors



Capacity: 1 750 l/min.



1



2



3

👁	Description	Size	Thread Type	Index
1	Adaptor PREVOST	1/4"	female thread	PNAKERP076101
2	Adaptor PREVOST	1/4"	male thread	PNAKERP076151
	Adaptor PREVOST	3/8"	male thread	PNAKERP076152
	Adaptor PREVOST	1/2"	male thread	PNAKERP076153
3	Adaptor PREVOST	9 mm	hose tailpiece	PNAKERP076809
	Adaptor PREVOST	13 mm	hose tailpiece	PNAKERP076813

Inflator gauges



👁	Description	Hose length	Range	Index
1	Inflator gauge ANI	40 cm	0-10 bar	PNAH060418
2	Inflator gauge EURODAINU	150 cm	0,07-11 bar	519-9356
3	Inflator gauge RACE CAR	60 cm	0-3,5 bar	519-9376
	Inflator gauge EURODAINU EM	300 cm	0,07-11 bar	519-9356EM**
	Spare hose EURODAINU	60 cm		519-9394
	Spare hose EURODAINU	150 cm		519-9387
	Spare hose EURODAINU	300 cm		519-9395
	Air Connector 8v1 WONDER for the hose 8 mm			562-5095
	Air Connector EM for the hose 8 mm			562-5088

Workshop tyre inflators



👁	Description	Dimensions of (H x W x D)	Range	Index
1	Digital wall mounted tyre inflator	245 x 255 x 125 mm	0-12 bar	PNUNIPA12K**
2	Tyre inflation safety cage 1200 x 550 mm	1410 x 1300 x 745 mm	-	TP518-0045**
3	Tyre inflation safety cage OTR	2000 x 2000 x 850	-	AT-4OTR**
4	Tyre inflation safety cage OTR MAX	2000 x 2000 x 1200	-	AT-4OTRMAX**
5	Tyre inflation safety cage OTR EM	2300 x 2300 x 1200	-	AT-4OTREM**

Pressure gauges



👁	Description	Range	Index
1	Digital pressure gauge	0-10 bar	519-9340
2	Tyre check dial gauge TWIN HOLD-ON	0-12 bar	PNPCLDPG-1H03
3	Tyre pressure gauge EM	0-12 bar	519-9319

** on request

Bolt indicators

The wheel nut and bolt covers are mounted to form a clear pattern of the location of the nuts in the vehicle. Changes in the position of the covers in relation to the original pattern inform about the loosening of a nut, informing about the possibility of failure of the braking system or bearings.



👁	Description	Size	Additional information	Index
1	CHECKPOINT indicator	27 mm	The wheel nut and bolt covers are mounted to form a clear pattern of the location of the nuts in the vehicle. Changes in the position of the covers in relation to the original pattern inform about the loosening of a nut.	561-2500
	CHECKPOINT indicator	30 mm		561-2510
	CHECKPOINT indicator	32 mm		561-2520
	CHECKPOINT indicator	33 mm		561-2530
2	CHECKTORQUE indicator	30 mm	To check if there is a damage in screw causing it to unscrew constantly. It is assumed after the clearances are indicated by CHECKPOINT, for the purpose of inspection, if a marked bolt has not unscrewed after a certain time or traveled distance	561-2560
	CHECKTORQUE indicator	32 mm		561-2570
	CHECKTORQUE indicator	33 mm		561-2580
3	CHECKLINK indicator	32 mm	dedicated to obstruct further movement of the loose a wheel nut by joining adjacent nuts	561-2600

Nut indicators



👁	Description	Size	Additional information	Index
1	Dustite LR wheel nut indicator	32 mm	A combined wheel nut indicator and dust cap specifically designed for wheels with trims and step rings.	561-2620
2	Dustite LR wheel nut indicator	33 mm		561-2630
3	Wheel nut cover with indicator 32 mm & 33 mm	32 / 33 mm	Mounting on a nut.	561-2640
3	Wheel nut cover without indicator 32 mm & 33 mm	32 / 33 mm		561-2650

Dustite removal tool



👁	Description	Additional information	Index
1	Dustite removal tool	significantly speeds up the time of disassembly of indicators, ensures no mechanical damage	561-2990

Wheel bolts, M12 x 1,25



1



2

Eye	Thread type	Thread length	Head type	Wrench size	Finish	Index
1	M12 x 1,25	24mm	taper	17	zinc plated	561-5001
	M12 x 1,25	26mm	taper	17	zinc plated	561-5036
	M12 x 1,25	26mm	taper	19	zinc plated	561-5002
2	M12 x 1,25	28mm	taper	17	zinc plated	561-5003
	M12 x 1,25	35 mm	taper	17	zinc plated	561-5057
	M12 x 1,25	40 mm	taper	17	zinc plated	561-5058
	M12 x 1,25	45 mm	taper	17	zinc plated	561-5059

Wheel bolts, M12 x 1,5



1



2



3

Eye	Thread type	Thread length	Head type	Wrench size	Finish	Index
1	M12 x 1,5	24mm	taper	17	zinc	561-5004
	M12 x 1,5	24mm	ball	17	zinc	561-5007
	M12 x 1,5	26mm	taper	19	zinc	561-5005
2	M12 x 1,5	28mm	taper	17	zinc	561-5006
	M12 x 1,5	28mm	taper	17	GEOMET - black	561-5056
	M12 x 1,5	35 mm	taper	17	zinc	561-5034
	M12 x 1,5	40 mm	taper	17	zinc	561-5035
3	M12 x 1,5	40 mm	ball	17	zinc	561-5009
	M12 x 1,5	45 mm	taper	17	zinc	561-5013

Wheel bolts, M14 x 1,5



1



2



3

Eye	Thread type	Thread length	Head type	Wrench size	Finish	Index
1	M14 x 1,5	28 mm	ball	17	zinc	561-5011
	M14 x 1,5	28 mm	ball	17	GEOMET - black	561-5072
	M14 x 1,5	35 mm	ball	17	zinc	561-5017
	M14 x 1,5	35 mm	ball	17	GEOMET - black	561-5071
	M14 x 1,5	40 mm	ball	17	zinc	561-5064
	M14 x 1,5	45 mm	ball	17	zinc	561-5018
	M14 x 1,5	45 mm	ball	17	GEOMET - black	561-5070
	M14 x 1,5	50 mm	ball	17	zinc	561-5065
	M14 x 1,5	55 mm	ball	17	zinc	561-5066
2	M14 x 1,5	28 mm	taper	17	zinc	561-5010
	M14 x 1,5	28 mm	taper	17	GEOMET - black	561-5069
	M14 x 1,5	35 mm	taper	17	zinc	561-5014
3	M14 x 1,5	35 mm	taper	17	GEOMET - black	561-5068
	M14 x 1,5	40 mm	taper	17	zinc	561-5060
	M14 x 1,5	45 mm	taper	17	zinc	561-5015
	M14 x 1,5	45 mm	taper	17	GEOMET - black	561-5067
	M14 x 1,5	50 mm	taper	17	zinc	561-5061
	M14 x 1,5	55 mm	taper	17	zinc	561-5062
	M14 x 1,5	60 mm	taper	17	zinc	561-5063

Wheel bolts, M14 x 1,25



Eye	Thread type	Thread length	Head type	Wrench size	Finish	Index
	M14 x 1,25	28 mm	taper	17	zinc	561-5073
1	M14 x 1,25	30 mm	taper	17	zinc	561-5016
2	M14 x 1,25	30 mm	taper	17	GEOMET - Black	561-5076
	M14 x 1,25	33 mm	taper	17	zinc	561-5074
	M14 x 1,25	45 mm	taper	17	zinc	561-5075

OEM Bolts for aluminum rims CITROEN PEUGEOT, M12 x 1,25



Eye	Thread type	Working part length	Seating type	Wrench size	Finish	Additional information	Index
1	M12 x 1,25	35 mm	flat mobile washer + cone	17	GEOMET	Citroen/Peugeot TUV	561-5012
	M12 x 1,25	37 mm		17	DACROMET	Citroen/Peugeot	561-5077
2	M12 x 1,25	50 mm		17	GEOMET	Citroen/Peugeot TUV	561-5039

OEM Bolts for aluminum rims VW AUDI SEAT SKODA, M14 X 1,5



Eye	Thread type	Thread length	Head type	Wrench size	Finish	Index
1	M14 x 1,5	35 mm	ball R14	17	zinc	561-5037
2	M14 x 1,5	34 mm	ball R14	19	black zinc	561-5038

Floating bolts for aluminum rims – PCD variations 1-2 mm



Eye	Thread type	Thread length	Head type	Wrench size	Finish	Index
1	M12 x 1,25	28 mm	floating cone	17	chrome	561-5042
	M12 x 1,5	28 mm	floating cone	17	chrome	561-5041
2	M14 x 1,5	27 mm	floating cone	17	chrome	561-5043

Bolt measuring tool

Eye	Description	Additional information	Index
1	Bolt measuring tool	The screw measure is intended for precise identification of the correct bolt size with thread and washer. Suitable for metric and inch screws	561-5501



Slim line bolts for aluminum rims – Torx wrench \varnothing 20mm



👁	Thread type	Thread length	Head type	Wrench size	Finish	Index
	M12 x 1,25	28 mm	taper	17/19	zinc	561-5031
	M12 x 1,5	26 mm	taper	17/19	zinc	561-5030
1	M14 x 1,5	28 mm	taper	17/19	zinc	561-5032
2	Wrench TORX	Wrench - Torx adapter for narrow TUV bolts and nuts (hexagonal head, 10 armed bottom)		17/19	zinc	561-5033

Slim line nuts for aluminum rims – Torx wrench \varnothing 20mm



👁	Thread type	Overall height	Head type	Wrench size	Finish	Info	Index
	M12 x 1,25	32 mm	taper	17/19	zinc	TUV	561-5251
	M12 x 1,5	32 mm	taper	17/19	zinc	TUV	561-5250
1	M14 x 1,5	32 mm	taper	17/19	zinc	TUV	561-5252
2	Wrench TORX	Wrench - Torx adapter for narrow TUV bolts and nuts (hexagonal head, 10 armed bottom)		17/19	zinc	TUV	561-5033

Nuts closed with collar for aluminum rims M12 x 1,25



👁	Thread type	Thread length	Head type	Wrench size	Finish	Info	Index
	M12 x 1,25	34 mm	taper	17	zinc	TUV	561-5234
	M12 x 1,25	34 mm	taper	17	zinc		561-5259
	M12 x 1,25	34 mm	taper	17	black coated		561-5262
1	M12 x 1,25	34 mm	cone with guide (guide length - 6 mm, outer diameter of guide - 16 mm)	19	zinc	TUV	561-5235
	M12 x 1,25	34 mm	taper	19	zinc		561-5260
	M12 x 1,25	34 mm	taper	19	black coated		561-5263
	M12 x 1,25	34 mm	taper	21	zinc	TUV	561-5233
	M12 x 1,25	34 mm	taper	21	zinc		561-5261
2	M12 x 1,25	34 mm	taper	21	black coated		561-5264
3	M12 x 1,25	35 mm	taper	19	chrome		561-5205
	M12 x 1,25	35 mm	taper	21	chrome		561-5206

Nuts closed with collar for aluminum rims M12 x 1,5



Eye	Thread type	Thread length	Head type	Wrench size	Finish	Info	Index
	M12 x 1,5	34 mm	taper	17	zinc	TUV	561-5230
	M12 x 1,5	34 mm	taper	17	zinc		561-5270
1	M12 x 1,5	34 mm	taper	19	zinc	TUV	561-5228
	M12 x 1,5	34 mm	taper	19	zinc		561-5254
	M12 x 1,5	34 mm	taper	21	zinc	TUV	561-5229
	M12 x 1,5	34 mm	taper	21	zinc		561-5255
2	M12 x 1,5	34 mm	cone with guide (guide length - 6 mm, outer diameter of guide - 16 mm)	19	zinc	TUV	561-5232
	M12 x 1,5	35 mm	taper	17	chrome		561-5217
	M12 x 1,5	35 mm	taper	17	black coated		561-5256
	M12 x 1,5	35 mm	taper	19	chrome		561-5209
3	M12 x 1,5	35 mm	taper	19	black coated		561-5257
	M12 x 1,5	35 mm	taper	21	chrome		561-5210
	M12 x 1,5	35 mm	taper	21	black coated		561-5258

Nuts closed with collar for aluminum rims M14 x 1,5



Eye	Thread type	Thread length	Head type	Wrench size	Finish	Info	Index
	M14 x 1,5	35 mm	taper	19	chrome		561-5213
	M14 x 1,5	35 mm	taper	21	chrome		561-5214
1	M14 x 1,5	35 mm	taper	21	zinc	TUV	561-5236
2	M14 x 1,5	35 mm	taper	21	black coated		561-5265
3	M14 x 1,5	36 mm	bigger cone	19	zinc	cone ended width: 24 mm	561-5271

Nuts closed with collar for aluminum rims M14 x 2,0



Eye	Thread type	Thread length	Head type	Wrench size	Finish	Index
1	M14 x 2,0	35mm	taper	19	chrome	561-5266

Nuts closed with collar for aluminum rims 1/2" 20UNF



Eye	Thread type	Thread length	Head type	Wrench size	Finish	Info	Index
1	1/2" 20UNF	34 mm	taper	19	chrome		561-5219
2	1/2" 20UNF	34 mm	taper	19	zinc	TUV	561-5220

Nuts opened with collar for aluminum rims M12 x 1,25



👁	Thread type	Overall height	Head type	Wrench size	Finish	Info	Index
1	M12 x 1,25	21 mm	taper	19	chrome		561-5215
2	M12 x 1,25	25 mm	taper	21	chrome		561-5221
	M12 x 1,25	25 mm	taper	19	zinc	TUV	561-5222

Nuts opened with collar for aluminum rims M12 x 1,5



👁	Thread type	Overall height	Head type	Wrench size	Finish	Info	Index
1	M12 x 1,5	21 mm	taper	19	chrome		561-5216
2	M12 x 1,5	25 mm	taper	19	zinc	TUV	561-5224
	M12 x 1,5	25 mm	taper	21	chrome		561-5225
	M12 x 1,5	25 mm	taper	21	zinc	TUV	561-5226

Nuts opened with collar for aluminum rims M14 x 1,5



👁	Thread type	Overall height	Head type	Wrench size	Finish	Info	Index
1	M14 x 1,5	25 mm	taper	19	chrome		561-5267

Nuts opened without collar for steel rims M12 x 1,25



👁	Thread type	Overall height	Head type	Wrench size	Finish	Index
1	M12 x 1,25	16 mm	taper	19	zinc	561-5201
	M12 x 1,25	16 mm	taper	19	black coated	561-5268
	M12 x 1,25	17 mm	taper	21	zinc	561-5202
2	M12 x 1,25	17 mm	taper	21	black coated	561-5269

Nuts opened without collar for steel rims M12 x 1,5



👁	Thread type	Overall height	Head type	Wrench size	Coating	Index
1	M12 x 1,5	16 mm	taper	19	zinc	561-5207
2	M12 x 1,5	16 mm	taper	19	black coated	561-5207 czarna
	M12 x 1,5	17 mm	taper	21	zinc	561-5208
	M12 x 1,5	17 mm	taper	21	black coated	561-5208 czarna

Nuts opened without collar for steel rims M14 x 1,5



👁	Thread type	Overall height	Head type	Wrench size	Coating	Index
1	M14 x 1,5	16 mm	taper	21	zinc	561-5212
2	M14 x 1,5	16 mm	taper	21	black coated	561-5218

OEM nuts for aluminum rims



👁	Thread type	Overall height	Head type	Typ	Wrench size	Coating	Info	Index
	M12 x 1,25	38 mm	flat washer	closed	21	chrome	NISSAN OEM	561-3004
	M12 x 1,5	27 mm	floating cone	opened	19	chrome	FORD OEM	561-3005
1	M12 x 1,5	35 mm	floating cone	closed	19	chrome	FORD OEM	561-3001
2	M12 x 1,5	37 mm	flat washer	closed	21	chrome	TOYOTA LEXUS MITSUBISHI OEM	561-3003
3	M14 x 1,5	35 mm	floating cone	closed	21	chrome	FORD OEM	561-3002

Inserted pins



👁	Thread type	Total length	Thread length	Jagger	Coating	Info	Index
1	M12 x 1,25	45 mm	25 mm	14,3 mm	zinc	TUV	561-5054
2	M12 x 1,5	47 mm	27 mm	14,3 mm	zinc	TUV	561-5053
	M14 x 1,5	43 mm	28 mm	15,7 mm	zinc	TUV	561-5078

Lock bolts, movable sleeve



1



2

👁	Thread type	Thread length	Head type	Wrench size	Coating	Index
	M12 x 1,25	28 mm	taper	17/19	zinc	561-6017
	M12 x 1,5	28 mm	taper	17/19	zinc	561-6016
1	M14 x 1,5	28 mm	taper	17/19	zinc	561-6010
	M14 x 1,5	30 mm	taper	17/19	zinc	561-6011
	M14 x 1,5	35 mm	taper	17/19	zinc	561-6012
2	M14 x 1,5	28 mm	ball	17/19	zinc	561-6013
	M14 x 1,5	35 mm	ball	17/19	zinc	561-6015

Lock nuts, movable sleeve



1



2



3

👁	Thread type	Thread length	Head type	Wrench size	Coating	Index
1	1/2UNF	37	taper	17/19	chrome	561-6213
	M12x1,25	37	taper	17/19	chrome	561-6211
	M12x1,5	37	flat washer	17/19	chrome	561-6214
	M12x1,5	37	movable, wide cone	17/19	chrome	561-6215
2	M12x1,5	37	taper	17/19	chrome	561-6210
3	M14x1,5	37	taper	17/19	chrome	561-6212

Lock nuts, movable sleeve



1

👁	Description	Additional information	Index
1	Nut cap remover	Cap puller is a special grip in the form of pliers designed to remove caps on wheel bolts on alloy wheels during seasonal tyre changes or repairs. For VW, Skoda, Audi, Seat.	561-9001

Torque wrenches



Eye	Description	Square drive	Range	Accuracy	Length	Weight	Info	Index
1	Torque wrench Jonnesway	1/2"	40 - 200 Nm	+/- 4%	531 mm	1,4 kg	for tightening screws with the right thread	JW-T27200N
2	Torque wrench NORBAR NorTorque	1/2"	40 - 200 Nm	+/- 3%	459 mm	1,0 kg	two-way mechanism ratchet - for tightening the screws with left and right threads	NO130104
	Torque wrench NORBAR NorTorque	1/2"	60 - 300 Nm	+/- 3%	588 mm	1,4 kg	two-way mechanism ratchet - for tightening the screws with left and right threads	NO130105
	Torque wrench Jonnesway	1/2"	60 - 340 Nm	+/- 4%	585 mm	1,5 kg	for tightening screws with the right thread	JW-T27340N
	Torque wrench Jonnesway	3/8"	10 - 60 Nm	+/- 4%	374 mm	0,6 kg	for tightening screws with the right thread	JW-T27060N



Eye	Description	Square drive	Range	Accuracy	Length	Weight	Info	Index
	PREMIUM							
1	Torque wrench NORBAR NorTorque	1"	300 - 1 000 Nm	+/- 4%	1 487 mm	7,3 kg	two-way mechanism ratchet (adjustable square) - for tightening the screws with left and right threads ratchet - for tightening the screws with left and right threads	NO120115.01

Impact wrench



1



2

👁	Description	Square drive	Maximum Torque (reverse)	Maximum Torque (forward)	Free speed	Weight	Air inlet	Min. Hose Size	Index
1	Impact wrench INVENTO	1/2"	1 600 Nm	870 Nm	8 500 rpm	2,1 kg	1/4"	10 mm (3/8")	PX23
2	Impact wrench PROXIMA	1/2"	1 220 Nm	949 Nm	9 000 rpm	2,7 kg	1/4"	10 mm (3/8")	PX43



1



2

👁	Description	Square drive	Maximum Torque (reverse)	Maximum Torque (forward)	Free speed	Weight	Air inlet	Min. Hose Size	Index
1	Impact wrench INVENTO	3/4"	2 000 Nm	1 290 Nm	8 500 rpm	2,1 kg	1/4"	10 mm(3/8")	PX25
2	Impact wrench INVENTO	3/4"	2 034 Nm	1 627 Nm	5 500 rpm	3,4 kg	3/8"	10 mm(3/8")	PX45

Air grinders and drills



👁	Description	Speed	Handle size	Weight	Length	Air inlet	Min. Hose Size	Additional information	Index
1	Grinder PX82	22 000 rpm	6 mm	0,6 kg	173 mm	1/4"	10 mm (3/8")	Includes 1/4 "and 6mm collets Power: 300 W	PX82
2	Grinder PX87	2 500 rpm	2 – 13 mm	0,89 kg	220 mm	1/4"	10 mm (3/8")	Quick-release keyless chuck entry tools	PX87

Ratchet wrench



👁	Description	Square drive	Max. Torque	Weight	Length	Air inlet	Min. Hose Size	Index
1	Ratchet wrench PX73	1/2"	108 Nm	1,3 kg		1/4"	10 mm (3/8")	PX73

Pneumatic tools oils



👁	Description	Capacity	Brand	Index
1	Pneumatic tools oil	600 ml	Airpress	PNOLEJN06
2	Pneumatic tools oil	1000 ml		PNOLEJN1
3	Pneumatic tools oil	2000 ml		PNOLEJN2
4	Pneumatic tools oil	1000 ml	Chicago Pneumatic	CPCPA1014

Impact wrench



1

👁	Description	Square drive	Maximum Torque (reverse)	Maximum Torque (forward)	Free speed	Weight	Air inlet	Min. Hose Size	Index
1	Impact wrench PROXIMA	1"	3 390 Nm	2 441 Nm	5 000 rpm	10,9 kg	1/2"	13 mm(1/2")	PX47L

Electric impact wrenches, 1"



1



2



3

👁	Description	Max. Torque	Minimum impact force	Rotation speed	Power	Weight	Height range	Index
1	Electric key MAX BOXER	2 500 Nm	400 Nm	410 rpm	1,5 kW	63 kg	31 – 73 cm	W-CT-MAX1
2	Electric key D.EL.TURBO MAXIT	2 500 Nm	600 Nm	400 rpm	1,5 kW	65 kg	32 – 73 cm	519-1719
3	Electric key ELMAX	2 500 Nm	370 Nm	360 rpm	1,1 kW	59 kg	37 - 71 cm	EL000-6000

Sockets in a cover for aluminum rims, sets

The suitable composite coating on the outer wall prevents scratching of the aluminum rim when adjusting the socket. The color finishing of caps guarantees quick identification of sizes. Sufficient length allows access to deep screw pockets. Kit with built-in reinforcement ring ensuring up to 7 times longer life to sockets without reinforcement.



1



2

👁	Description	Size	Wrench	Length	Number of elements	Index
1	Socket set with reinforcement ring	1/2"	17, 19, 21	85 mm	3 pcs.	W-KS515.0990
2	Set of sockets in the cover	1/2"	17, 19, 21	85 mm	3 pcs.	BGS-7310

Sockets in a cover for aluminum rims

The sockets have a protective sleeve made of soft plastic, which protects the rim against damage to the paint coating. Ultra-thin walls allow you to unscrew the screws in the tight sockets of the aluminum rims.



1

2

3

4

👁	Description	Size	Wrench	Length	Index
1	Socket long plastic	1/2"	17	85 mm	BGS-7201
2	Socket long plastic	1/2"	19	85 mm	BGS-7202
3	Socket long plastic	1/2"	21	85 mm	BGS-7203
4	Socket long plastic	1/2"	22	85 mm	BGS-7208

Impact socket for safety screws Mercedes



👁	Description	Size	Wrench	Length	Index
1	Impact socket for safety screws Mercedes	1/2"	17	86 mm	TECHAWSM17

Impact sockets long Chicago Pneumatic

Lifetime warranty on Chicago Pneumatic sockets against breakage.



1



2

👁	Description	Size	Wrench	Length	Index
1	Socket Long Chicago Pneumatic	1/2"	17	78 mm	CP4007
	Socket Long Chicago Pneumatic	1/2"	18	78 mm	CP4008
	Socket Long Chicago Pneumatic	1/2"	19	78 mm	CP4009
	Socket Long Chicago Pneumatic	1/2"	21	78 mm	CP4010
	Socket Long Chicago Pneumatic	3/4"	19	85 mm	CP4248
	Socket Long Chicago Pneumatic	3/4"	21	85 mm	CP4250
	Socket Long Chicago Pneumatic	3/4"	22	85 mm	CP4251
	Socket Long Chicago Pneumatic	3/4"	24	85 mm	CP4253
	Socket Long Chicago Pneumatic	3/4"	27	85 mm	CP4256
	Socket Long Chicago Pneumatic	3/4"	30	85 mm	CP4259
	Socket Long Chicago Pneumatic	3/4"	32	85 mm	CP4261
	Socket Long Chicago Pneumatic	3/4"	33	85 mm	CP4262
	Socket Long Chicago Pneumatic	1"	24	90 mm	CP4407
	Socket Long Chicago Pneumatic	1"	27	90 mm	CP4410
	Socket Long Chicago Pneumatic	1"	30	90 mm	CP4413
	Socket Long Chicago Pneumatic	1"	32	90 mm	CP4414
2	Socket Long Chicago Pneumatic	1"	33	90 mm	CP4415

Impact sockets long



1



2



3



4



5

👁	Description	Size	Wrench	Length	Index
1	Socket long	1/2"	17	78 mm	BGS-7217
	Socket long	1/2"	19	78 mm	BGS-7219
	Socket long	1/2"	21	78 mm	BGS-7221
	Socket long	1/2"	22	78 mm	BGS-7222
2	Impact adaptor	3/4" in - 1" out		35 mm	BGS-195
3	Impact adaptor	1" in - 3/4" out		43 mm	BGS-196
4	Impact adaptor	3/4" in - 1/2" out		30 mm	BGS-275
5	Impact adaptor	1/2" in - 3/4" out		20 mm	BGS-279

Impact sockets long

Chicago Pneumatic Chrome Molybdenum Steel (Cr-Mo) sockets, lifetime warranty against cracking



1



2

👁	Description	Size	Wrench	Length	Number of elements	Index
1	Socket set (SS4114)	1/2"	10, 11, 12, 13, 14, 15, 16, 17, 18, 19, 21, 22, 26, 27	85 mm	14 pcs.	CP000-0405
2	Socket long set (SS814D)	1"	27, 32, 33, 36	90 mm	4 pcs.	CP000-0412

Sockets for damage screws

They have a special shape inside that allows the cap to cut into the damaged screw, which allows it to be unscrewed (practically impossible with standard impact sockets).



1



3



2



4

👁	Description	Size	Wrench	Length	Number of elements	Index
1	Socket set for "difficult" screws	1/2"	17, 19, 21, 22, 24	50 mm	6 pcs.	HAH-PN761
2	Set for removing screws securing the wheels	1/2"	Ø 18.3 x Ø 16.4 mm; Ø 19.5 x Ø 17.6 mm Ø 20.4 x Ø 18.5 mm; Ø 21.6 x Ø 19.7 mm Ø 22.5 x Ø 20.6 mm; Ø 23.6 x Ø 21.7 mm Ø 24.5 x Ø 22.6 mm; Ø 25.5 x Ø 23.6 mm	60 mm	11 pcs.	BGS-8656
3	Unscrewing socket set damaged screws	3/8" 1/2"	3/8": 8, 10, 12, 13 mm 1/2": 14, 15, 16, 17, 19, 21 mm	32 mm 34 mm	11 pcs.	W-WT2011
4	Set of long sockets to damaged and seized screws	1/2"	17, 19, 21, 22	150 mm	5 pcs.	BGS-5262

Cabinet tool and tool case



1



2

👁	Description	Numer of elements	Number of drawers	Index
1	Cabinet tool, INVENTO	220 pcs.	6	INVTT220-6
2	Socket set, INVENTO	108 pcs.		INVZN-108

Four-way wheel wrench



1



2

👁	Description	Dimensions	Index
1	Four-way wheel wrench	17x19x22x1/2"	840-0073X
2	Four-way wheel wrench	13/16X17X19X22	W-WT8240

Depth gauge



1



2



3



4

👁	Description	Type	Measurement range	Index
1	Depth gauge	analog	0 - 30 mm	519-1653
2	Depth gauge	analog	0 - 26 mm	PNPCLTDG-16C1
3	Digital depth gauge	digital	0 - 28 mm	519-1830
4	Depth gauge	analog	0 - 50 mm	519-1655

Lighting



👁	Description	Index
1	Workshop lamp mounted under the hood 15W SMD LED	W-MM007935030070
2	Rotating workshop lamp 3 W COB LED + 3 W SMD LED front lighting	W-MM007935030030
3	LED lamp 3W COB	W-BGS9651
4	Workshop lamp COB LED 350 lm	W-WTB5010
5	LED-Headlight 12 LED	W-BGS9711

Accessories to lift



👁	Description	Capacity	Index
1	Transport rollers on wheels	600 kg	W-BGS8604
2	Jack stands	3 000 / 6 000 kg	INVTJ02 / INVTJ03
3	Transmission jack	500 kg	W-WT-E6110

Rubber hammer



👁	Description	Weight	Index
1	Rubber hammer	1,3 kg	W-BGS1868
2	Rubber hammer	4,5 kg	W-WT1375

Oil pan



1



2

👁	Description	Capacity	Index
1	Oil drainer pan	10 L	INVT001
2	Oil drainer pan	16 L	INVT002

Accessories



1



2

👁	Description	Capacity	Index
1	Car creeper	150 kg	INVTL01
2	Service cabinet	140 kg	INVTL02

Special equipment



1



2

👁	Description	Push	Index
1	Hydraulic shop press	20T	INVTP01
2	Hydraulic spring compressor	1T	INVTP02

INVENTO

QUALITY AND INVENTION

35 years of experience | Over 100 models | High quality | Tested
| Customer support | Experienced technicians | Recommended by authorized garages



Lifts



Tyre changers



Wheel balancers



AC machines



Wheel alignment



Tools

Posts lifts



1



2



3



4



5

👁️	Description	Capacity	Maximum lifting height	Minimum lifting height	Arms length	Overall height	Connection between columns	Index
1	INVENTO EL 240	4 t	1 900 mm	98 mm	740 - 1 310 mm	2 844 mm	bottom	INVEL240
2	INVENTO EL 240 S	4 t	1 800 mm	100 mm	702 - 1 050 mm / 858 - 1 365 mm	2 812 mm	bottom	INVEL240-S
3	INVENTO EL 250L	5 t	1 900 mm	120 mm	860 - 1 800 mm	2 848 mm	bottom	INVEL250
4	INVENTO EL 246 TL	4,6 t	1 794 mm	88 mm	640-1 100, 900-1 475 mm	4 162 mm	top	INVEL246TL
5	INVENTO EL 246 TL/H2	4,5 t	1 794 mm	88 mm	640-1 100, 900-1 475 mm	3 862 mm	top	INVEL246TL-H2

Scissor lifts



1



2



3



4



5



6

👁	Description	Capacity	Maximum lifting height	Minimum lifting height	Platform length	Platform width	Width between platforms	Total width	Index
1	INVENTO SL 130E	3 t	1 000 mm	110 mm	1 450/1 984mm	520 mm	821 mm	1 861 mm	INVSL130E
2	INVENTO SL 235	3,5 t	1 850 mm	115 mm	1 435/1 980mm	600 mm	800 mm	2 000 mm	INVSL230
3	INVENTO SL 232 S	3,2 t	1 900 mm	110 mm	1 470/2 042 mm	630 mm	900 mm	2 160 mm	INVSL232S
4	INVENTO SL 230 LNI	3 t	2 030 mm	0 mm	1 640 - 2 040 mm	550 mm	800 mm	1 900 mm	INVSL230LNI
5	INVENTO SL 230 LNIS	3 t	1 800 mm	0 mm	1 660 - 2 060 mm	570 mm	800 mm	1 940 mm	INVSL230LNIS
6	INVENTO ML 600	0,6 t	905 mm	260 mm	1 800 mm	600 mm		1 200 mm	INVML600

Scissor lifts



1



2

👁	Description	Capacity	Maximum lifting height	Lift table maximum lifting height	Platform length	Platform width	Total width	Play detector	Index
1	INVENTO SL 448 LT	4 t	2 160 mm	430 mm	4 800 mm	997 mm	2 100 mm	✗	INVSL448LT
1	INVENTO SL448 LTPD	4 t	2 160 mm	430 mm	4 800 + 600 mm	984 mm	2 200 mm	✓	INVEL246
2	INVENTO SL550 LT	5 t	2 160 mm	430 mm	5 000 mm	997 mm	2 213 mm	✗	INVSL550LT
2	INVENTO SL 550 LTPD	5 t	2 160 mm	430 mm	5 000 + 607 mm	984 mm	2 202 mm	✓	INVSL550LTPD
2	INVENTO SL550 LT Heavy Duty	5 t	2 160 mm	430 mm	5 000 mm	997 mm	2 213 mm	✗	INVSL550LT_HD

Four posts lifts



1



2

👁	Description	Capacity	Maximum lifting height	Overall height	Platform length	Overall width	Slipping plate	Space for turntables	Index
1	INVENTO EL 442	4,2 t	1 800 mm	2263 mm	4 808 mm	3 154 mm	✗	✗	INVEL442
1	INVENTO EL 442WA	4,2 t	1 850 mm	2263 mm	4 808 mm	3 154 mm	✓	✓	INVEL442WA
2	INVENTO EL 464	6,4 t	1 900 mm	2 362 mm	5 216 mm	3 320 mm	✗	✗	INVEL464
2	INVENTO EL 464WA	6,4 t	1 900 mm	2 362 mm	5 216 mm	3 320 mm	✓	✓	INVEL464WA

Board lifts

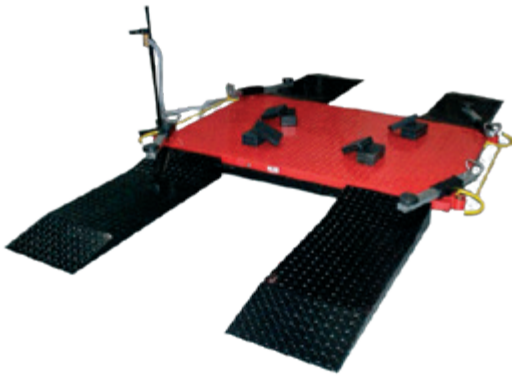

1

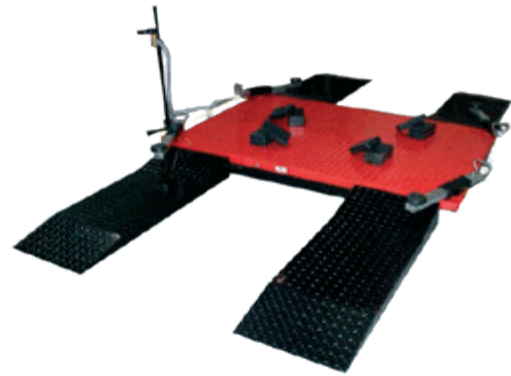

2

👁	Description	Capacity	Maximum lifting height	Minimum lifting height	Length without ramps	Width	Index
1	Board lift AT-2H	2 t	625 mm	130 mm	1 250 mm	2 000 mm	AT000-1001H / AT000-1004H
2	Board lift AT-2HHD	3,5 t	625 mm	130 mm	1 250 mm	2 000 mm	AT000-1001HHD / AT000-1004HHD

Accessories for lifts



1

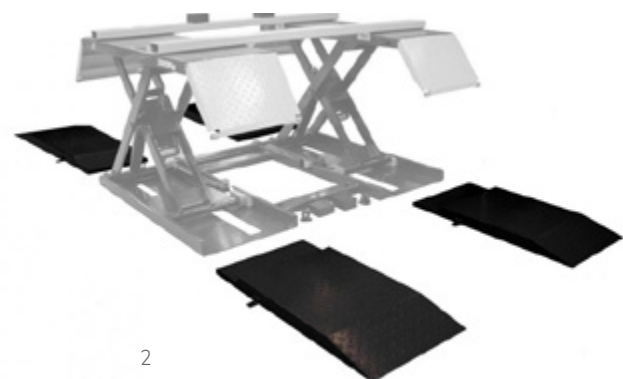

2

👁	Description	Pieces	Length	Index
1	On-ground instalation kit	2	1,3 m	INVSL001
1	Long ramps for lifts S L448 / SL 550	2	2 m	INVSL005
2	Ramps for lifts SL 235 / SL 130E	4	1,065 m	INVSL006

Jacking beam and pit jacks

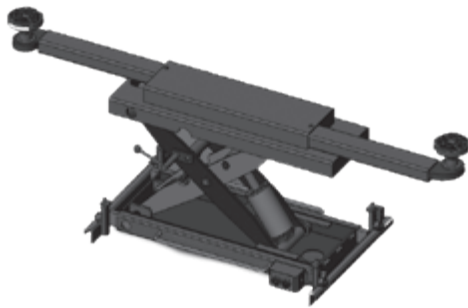

1



2



3

👁	Description	Capacity	Maximum lifting height	Width	Air supply	Control	Index
1	Jacking beam for SL 448 /SL 550	2,5 t	643 mm	830 - 1 000 mm	6 - 10 bar	Manual	INVSLHJ-75B
2	INVENTO Pit jacks	6 / 16 t	470 / 650 mm	800 - 950 mm		Manual	W-SK-W8210/SD / W-SK-8220/SD
3	Cattini YAK 1615H PREMIUM	15 t	600 mm	850 - 1 150 mm	8 - 10 bar	Remote	CAYAK-1615H

Bottle jack



1

👁	Description	Capacity	Index
1	Bottle jack Compac CBJ10	10 t	COCBJ10
1	Bottle jack Compac CBJ20	20 t	COCBJ20G2
1	Bottle jack Compac CBJ30	30 t	COCBJ30

Jacks



1



2



3



4



5

👁	Description	Capacity	Maximum lifting height	Minimum lifting height	Pistons	Air supply	Weight	Guarantee	Index
1	INVENTO AHL30 PREMIUM	30/15 t	289 mm	150 mm	2	8 - 12 bar	38 kg	1 year	INVAHL30
2	Cattini YAK 215N / YAK 217N PREMIUM	40/20 t	300 / 341 mm	150 / 170 mm	2	8 - 10 bar	39 / 41 kg	3 years	CAYAK-215N / CAYAK-217N
3	Cattini YAK222N PREMIUM	60/30 t	450 mm	220 mm	2	8 - 10 bar	71 kg	3 years	CAYAK-222N
4	Cattini YAK 330S PREMIUM	80/50/25 t	835 mm	310 mm	3	8 - 10 bar	50 kg	3 years	CAYAK-330S
5	Cattini YAK 312 PREMIUM	60/30/15 t	255 mm	120 mm	2	8 - 10 bar	103 kg	3 years	CAYAK-312

Air jacks



1



2



3

👁	Description		Capacity	Maximum lifting height	Minimum lifting height	Air supply	Weight	Guarantee	Index
1	Air jack J4a	ECONOMY	3,5 t	395 mm	140 mm	6 - 8 bar	28 kg	1 year	CAJ4a
2	INVENTO J3C	ECONOMY	3 t	400 mm	140 mm	6 - 12 bar	18 kg	1 year	INVTJ01
3	Air Jack J2, J3	ECONOMY	2 t	370 / 450 mm	140 / 155 mm	6 - 8 bar	17 / 20 kg	1 year	CAJ2 / CAJ3

Jacks



1



2



3



4



5

👁	Description		Capacity	Maximum lifting height	Minimum lifting height	Total width	Total length	Weight	Guarantee	Index
1	Big Red 3T	ECONOMY	3 t	500 mm	145 mm				1 year	W-BR-TPH0015
2	Compac 2T-C	PREMIUM	2 t	500 mm	80 mm	380 mm	730 mm	37 kg	3 years	CO2T-C
3	Compac 3T-C	PREMIUM	3 t	500 mm	115 mm	380 mm	1 015mm	42 kg	3 years	CO3T-C
4	Compac 2T-77	PREMIUM	2 t	480 mm	77 mm	380 mm	950 mm	41 kg	3 years	CO2T-77G2
5	Compac 6T-C	PREMIUM	6 t	570 mm	155 mm	470 mm	1 395 mm	90 kg	3 years	CO6T-C

Accessories for Cattini jacks



1



2



3



4

👁	Description	Height	Index
1	Extension, plate	10 mm	CAYAK-PL10
2	Extension	70 mm	CAYAK-PL70
3	Extension	120 mm	CAYAK-PL120
4	Optional pneumatic wheels for YAK 330/S		CAYAK-A00502

Accessories for lifts

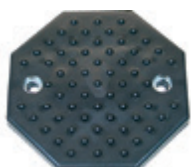

1



2



3

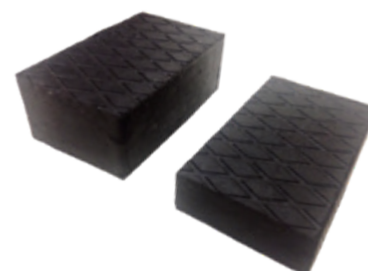

4

5



6



7



8



9



10

👁	Description	Dimensions / Thickness	Index
1	Rubber pad (octagonal)		INVEL002
2	Rubber for Compac (except 2T-77)		CO1002LF
3	Rubber for lifts Mondolfo Ferro	130x120x25 mm	MF4-326483
4	Rubber pad	7 cm	AT000-1000A
5	Rubber pad	4 cm	AT000-1000
6	Rubber pad for EL 240 / EL 250		INVEL001
7	Rubber pad for EL 246		INVEL007
8	Rubber pad for hydraulic jacks	100x30 mm	AT000-0002
9	Rubber for Compac 2T-77, 1.4 T-HC		CO1077
10	Rubber for lifts	130x110x26 mm	AT000-0003

Tyre changers



1



2



3

👁	Description	Outside clamping capacity	Maximum tyre width	Number of gears	Helper arm	Pumping the wheel	Index
1	INVENTO TC M24	6-24"	12"	1		pedal	INVTCM24
2	INVENTO TC 720 2V	10-20"	12"	2		pedal	INVTC7202V
3	INVENTO TC 720 2V HA with helper	10-20"	12"	2	✓	pedal	INVTC7202VHA

Tyre changers



4



5



6



7

👁	Description	Outside clamping capacity	Maximum tyre width	Number of gears	Helper arm	Pumping the wheel	Index
4	INVENTO TC 722 2V	10-22"	12"	2		pedal	INVTC7222V
5	INVENTO TC 722 2V HA with helper	10-22"	12"	2	✓	pedal	INVTC7222VHA
6	INVENTO TC 724 2V	10-24"	14"	2		pedal	INVTC7242V
7	INVENTO TC 724 2V HA with helper	10-24"	14"	2	✓	pedat	INVTC7242VHA

Helper arm



1



2

👁	Description	Application	Index
1	INVENTO HA 320B	INVENTO TC 720, TC 722	INVHA320B
2	INVENTO HA 390	INVENTO TC 724	INVHA390

Truck Tyre Changers



1



2



3



4

👁	Description	Maximum tyre width	Maximum tyre diameter	Clamping capacity	Automatic control	Maximum clamping force	Maximum liftable wheel weight	Index
1	INVENTO TC 823 Mobile	600 mm	1300 mm	13-26"		750 kg	750 kg	INVTC823M
2	INVENTO TC 826	760 mm	1500 mm	14-26"		1500 kg	1000 kg	INVTC826
3	INVENTO TC 856	1100 mm	2200 mm	14-56"	✓	2800 kg	1500 kg	INVTC856
4	INVENTO TC 856 N	1100 mm	2200 mm	14-56"		2800 kg	1500 kg	INVTC856N

Tyre changers accessories



1



2



3



4



5



6



7



8

 Description	Index
1 Mounting Aid - rim protection	MF31100149
2 Mounting Head for INVENTO TC	INVTC6000303
3 Plastic mounting head for Hofmann / John Bean	AM-HO-ST08A
4 Plastic mounting head for Cemb	AM-CB-ST02
5 Tyre bead protection - black	MF801461007A
6 Tyre bead protection - yellow	MF8-11120014S
7 Reducing / increasing jaws for TC720 / 722 - 4 pcs.	INVTC6008831
8 Reducing / increasing jaws for TC724 - 4 pcs.	INVTC6008832

Tyre changers accessories

 Description	Index
1 Corghi Mondolfo demounting head protection - front (yellow)	AM-CO-ST01
2 Corghi Mondolfo demounting head protection - rear (yellow)	AM-CO-ST02
3 Butler Ravaglioli demounting head protection - front	AM-BU-ST01
4 Butler Ravaglioli demounting head protection - rear	AM-BU-ST02
5 INVENTO TC demounting head protection - front	INVTTC5509015
6 INVENTO TC demounting head protection - rear	INVTTC5509014
7 INVENTO TC demounting head protection - front (pressed in)	INVTTC1300014
8 M&B / Werther demounting head protection	AM-MB-ST01
9 Hofmann / John Bean demounting head protection	AM-HO-ST01
10 Hofmann / John Bean demounting head protection Snap-on	AM-HO-ST07
11 Cemb / Hofmann MP / Giuliano demounting head protection - front	AM-CB-ST01
12 Cemb / Hofmann MP / Giuliano demounting head protection - rear	AM-HO-ST02
13 Cemb / Hofmann MP / Giuliano demounting head protection system QX- front	AM-HO-ST03
14 Cemb / Hofmann MP / Giuliano demounting head protection NEW TYPE - front	AM-HO-ST05
15 Cemb / Hofmann MP / Giuliano demounting head protection NEW TYPE - rear	AM-HO-ST06
16 Cemb / Hofmann MP / Giuliano demounting head protection OLD TYPE - front	AM-HO-ST09
17 Bosch / Beissbarth / Sicam demounting head protection (roll)	AM-SC-ST01
18 Bosch / Beissbarth / Sicam demounting head protection (screw)	AM-SC-ST02
19 Bosch / Beissbarth / Sicam demounting head protection - rear	AM-SC-ST03
20 Hunter / Sicam demounting head protection - front	AM-SI-ST01
21 Hunter / Sicam demounting head protection - rear	AM-SI-ST02
22 UNI-TROL demounting head protection	AM-UN-ST01

Tyre changers accessories



 Description	Index
1 Leverless tool head plastic protections front - old type Mondolfo / Corghi	AM-CO-ST03
2 Leverless tool head plastic protections front - new type Mondolfo / Corghi	AM-CO-ST04
3 Leverless tool head plastic protections rear - Mondolfo / Corghi	AM-CO-ST05
4 Screw for leverless tool head plastic protections	AM-CO-ST06
5 Jaw cover long INVENTO TC 720	INVTC8000025
6 Jaw cover short INVENTO TC 720	INVTC8000005
7 Jaw cover long INVENTO TC 722 / TC 724	INVTC8000026
8 Jaw cover short INVENTO TC 722 / TC 724	INVTC8000006
9 Plastic protection Sicam / Beissbarth / Bosch	AM-SC-SC01
10 Plastic protection Cemb / Giuliano / Hofmann	AM-CB-SC01
11 Plastic protection Hofmann / John Bean / Boxer	AM-HO-SC01
12 Plastic protection Corghi	AM-CO-SC01
13 Plastic protection UNI-TROL	AM-UN-SC01
14 Plastic protection M&B / Werther	AM-MB-SC01

Tyre changers accessories



1



2



3



4



5



6



7



8

 Description	Index
1 Plastic protection fo tyre lever	MF19110049
2 Crowbar cover	INVTC5309016
3 Plastic protection INVENTO / Evert(IC) / Dunlop	INVTC5509018
4 Plastic protection Sicam/Beissbart / Bosch (roll)	AM-SC-SZ01
5 Plastic protection Hofmann / John Bean / Boxer	AM-HO-SZ01
6 Plastic protection Cemb / Hofmann MP/ Giuliano	AM-CB-SZ01
7 Rubber for bead breaker INVENTO TC 720 TC 722	INVTC5004093
8 Rubber for bead breaker INVENTO TC 724	INVTC5004094



👁	Description	Length	Index
1	Tyre lever	500 mm	840-0444
2	Tyre lever (straight)	600 mm	840-0451
3	Tyre lever for VAN	600 mm	840-0482
4	Tyre lever for ring wheels	450 mm	519-6926
5	Tyre lever EM- SAYAM	950 mm	519-6933
6	Tyre lever for motorcycle wheels - MOTO	380 mm	519-9002
7	Tyre lever Force	750 mm	519-9026
8	Tyre lever short	199 mm	571-9600

Tyre changers accessories



 Description	Index
1 Rim clamp for tubeless truck rims	INV2200113
2 Rim clamp for tubeless truck alloy rims	INV2200114A
3 Crowbar truck	INVTC826.00.01.00A
4 Tyre lever LKW 940, type M	519-6964
5 Tyre lever LKW 940, type L	519-9071
6 Tyre changer for tubeless tire- set	519-9186B
7 Crowbar truck	519-9187
8 One-sided lever with a roller (cross)	519-9187A
9 Lever for Duplex Rim	519-6919
10 Tyre lever Halte - 800mm	519-9019
11 Tyre lever FIACRE for MICHELIN - 450 mm	519-6957
12 40L tire bead seater	519-3915
13 20L tire bead seater	519-3910

Wheel balancers



👁	Description	Display	Measurement of the diameter and distance of wheel	Width measurement	LED lighting	Laser	Positioning at the point of imbalance	Handle type	Index
1	INVENTO VB 300M	LED	manual	manual				14 mm motorcycle shaft	INVB300M
2	INVENTO VB 300	LED	manual	manual				nut	INVB300
3	INVENTO VB 350	LED	measuring arm	manual	✓			nut	INVB350
4	INVENTO VB 470	LCD	measuring arm	manual	✓	✓		nut	INVB470
5	INVENTO VB 510	LCD	measuring arm	measuring arm	✓	✓	✓	nut	INVB510

Wheel balancers TRUCK



1



2



3

👁	Description	Display	Measurement of the diameter and distance of wheel	Width measurement	Brake	Max. rim diameter	Max. wheel weight	Index
1	INVENTO VB 760	LED	manual	manual	pedal	24"	200 kg	INVB760
2	INVENTO VB 780	LED	measuring arm	manual	automatic	28"	200 kg	INVB780
3	INVENTO VB 810	LCD	measuring arm	automatic	automatic	32"	200 kg	INVB810

Wheel balancers accessories

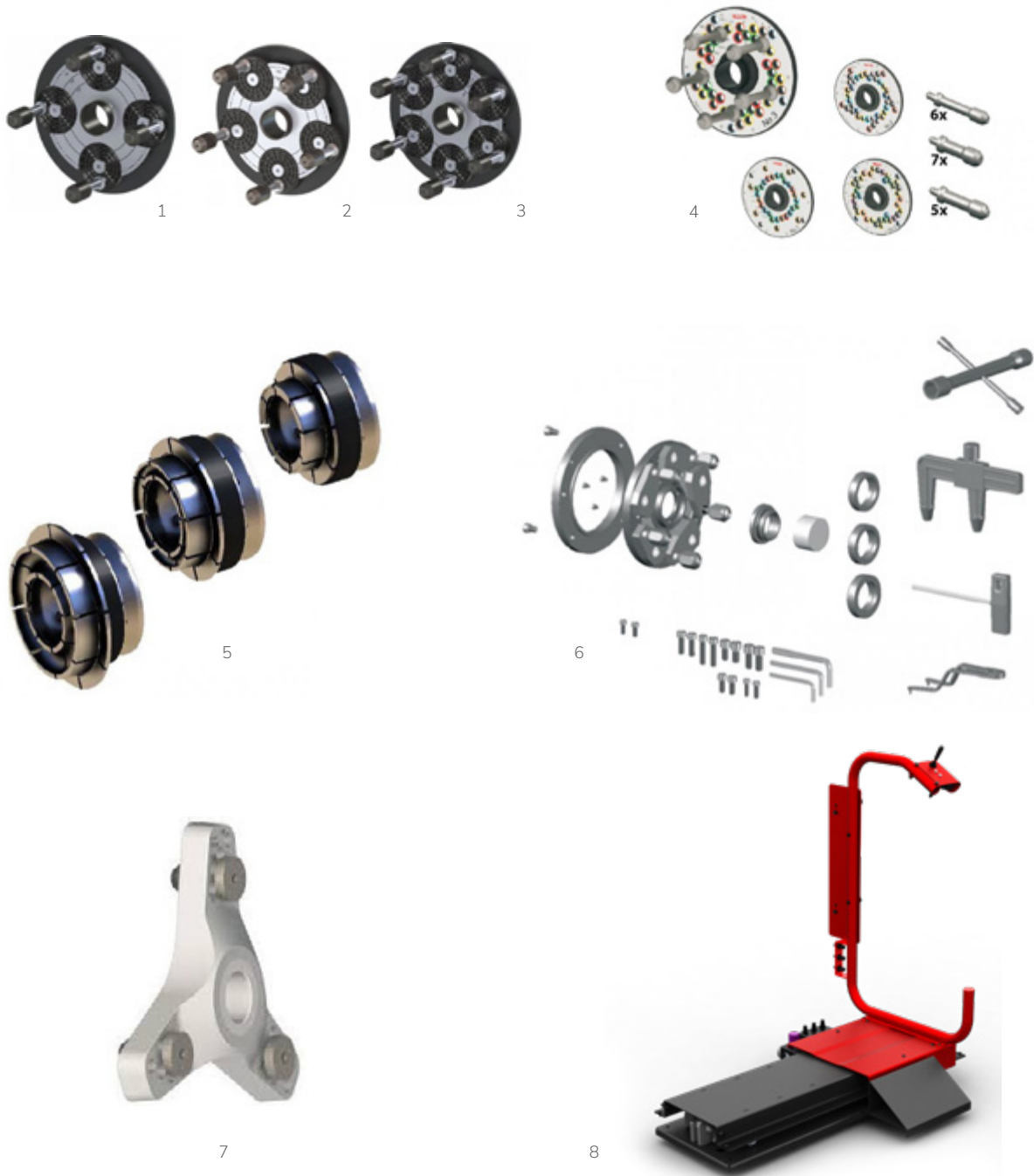

👁	Description	Index
1	Haweka Quick Plate IV	HA249011400
2	Haweka Quick Plate V	HA259011400
3	Haweka Quick Plate VI	HA269011400
4	Haweka World Kit II	HA200018405
5	Haweka DUO-EXPERT 40 mm, 3 sleeves in a case 54 - 78 mm	HA165400005
6	Haweka UNI LUG 40 mm - holder for rims without holes	HA405401108
7	Haweka 3-point star with pin	HA700400021
8	Universal wheel lifter for wheel balancers	INV6008845

Wheel balancers accessories



1



2



3



4



5



6



7

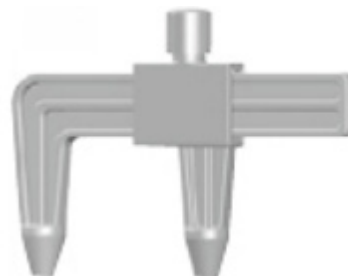

8

 Description	Index
1 Haweka Pro-Grip 40x3 with accessories	HA124403000
Haweka Pro-Grip 40x4 with accessories	HA124405000
2 Quick-Nut 36x3 mm	INVB6001036
Quick-Nut 40x3 mm	INVB6001040
3 Big plastic cap (hubcap) quick-clamping nuts	HA190008002
4 INVENTO Clamping hood	INVB6001101
5 Haweka Rubber cover	HA190008005
6 Alu rim hubcap - 210mm	HA190008021
7 Calipers	519-9947
8 Uni Lug caliper	HA490008000

Wheel balancers accessories



 Description	Index
1 Haweka VAN cone set. 88-174 / 40 mm	HA150400026
2 Haweka cone 94-132 / 40 mm	HA150400049
3 Haweka cone 122-174 / 40 mm	HA150400043
4 Haweka cone 42-65 / 40mm	HA150400008
5 Haweka cone 53-80 / 40mm	HA150400009
6 Haweka cone 74-111 / 40mm	HA150400012
7 INVENTO cone 42-65 / 40 mm	INVB6004001
8 INVENTO cone 54-78 / 40 mm	INVB6004002
9 INVENTO cone 71-107 / 40 mm	INVB6004003
10 Haweka cone 44-80 / 40 mm	HA150400011

A/C stations



1



2

👁	Description	Refrigerant	Valves	Tank	Vacuum pump	Injection oil/UV	Display	Index
1	INVENTO Handy Advance R134a	R134a	Manual	10 kg	70 l/min.	time	4,7"	INVHA-R134a
2	INVENTO Handy Advance R1234yf	R1234yf	Manual	10 kg	70 l/min.	time	4,7"	INVHA-R1234yf

Consumables



1



2



3



4



5



6



7



8

👁	Description	Index
1	R134a 12 kg refrigerant	TX134a-12,0
1	R134a 12 kg bottle	TX134aBUTLA
2	R1234yf 5 kg refrigerant	TX1234yf-5,0
2	R1234yf 5 kg bottle	TX1234yfBUTLA
3	UV dye R134a, 240 ml	TXUV240
	UV dye R134a, 1 L	TXUV1L
	UV dye R1234yf, 350 ml	TXUV240-R1234yf
	PAG 46 oil, 250 ml	TXPAG46
4	PAG 46 oil, 1 L	TXPAG46-1L
	PAG 46 oil, 1 L Specol	TXPAG46-1L-S
5	PAG 46 oil with UV, 1L Specol	TXPAG46UV-1L-S
	PAG 100 oil, 250 ml	TXPAG100
	PAG 100 oil, 1 L	TXPAG100-1L
	PAG 100 oil with UV, 1 L	TXPOE100UV-1L
6	PAO 68 oil, 1 L	TX8FX351214021
	PAO 68 oil with UV, 1 L	TX8FX351214211
	PAG 46 oil R1234yf, 250 ml / ND12	TXPAG1234YF_46
	PAG 100 oil R1234yf, 250 ml / ND12	TXPAG1234YF
7	PAG 46 oil R744 (CO2), 1 L	TXPAG46-1L-R744
8	UV dye R744 (CO2), 250 ml	TXUV250-R744

Leak detection



Image	Description	Index
1	Leak detection kit - Magneti Marelli	TX13.210
2	Leak detection kit	TX14.011
	Nitrogen-hydrogen cylinder (N2-H2), 1 L	TX13.211
3	Nitrogen-hydrogen cylinder (N2-H2), 2 L	TX13.215
4	Manifolds R134a	TX14.006
5	Manifolds R1234yf	TX14.007
6	Pressure regulator, 16 bar	TX14.009
	Pressure regulator, 30 bar	TX14.010
7	UV lamp, 100W/12V	TX55.010
8	UV lamp, LED	TX55.001
	Goggles UV	TX533120K
9	Electronic Leak Detector H2	TX13.212
	Leak detection foam	TX8PE351226061
10	Sealant with UV, R134a, 30 ml	TX11.013UV
	Sealant with UV in syringe, R134a, 6 ml	TX11.015UV
11	Sealant with UV in syringe, R1234yf, 6 ml	TX11.017UV
	UV remover, 400 ml	TX11.024

Disinfection



👁	Description	Index
1	Ozone generator 10 g/h, 230V	TX15.001
2	Ozon concentration meter HT520	TX15.002
3	Ozon concentration meter HT530	TX15.003
4	Disinfection spray, 400 ml	TX11.028
5	Disinfection spray Motip, 500 ml	MT090508
6	Disinfection spray Aircon-Klick, 150 ml	TX4580
7	Car scent, 12 pcs.	TX3902254
8	Nanoclean disinfection kit PROFI	TX15.010
	Nanoclean disinfection kit FOG	TX15.011
9	Nanoclean disinfection liquid 5 L, Citrus	TX15.012
	Nanoclean disinfection liquid 5 L, Lavender	TX15.013
10	Nanoclean disinfection liquid 1 L, Citrus	TX15.014
	Nanoclean disinfection liquid 1 L, Lavender	TX15.015
11	Nanoclean Spray, 400 ml	TX15.016

A/C gas analyzers



👁	Description	Refrigerant	Index
1	Gas analyzer, Spin	R134a / R1234yf	INVHA003
2	Gas identifier	R134a	TX7935090940
3	Gas identifier	R1234yf	TX7935021060

Quick couplers



👁	Description	Connector	Refrigerant	Index
1	Quick coupler Parker	LP	R1234yf	TX7935020120
2	Quick coupler Parker	HP	R1234yf	TX7935020130
3	Quick coupler	LP	R1234yf	TX7950024940
4	Quick coupler	HP	R1234yf	TX7950024930
5	Quick coupler Parker	LP	R134a	TX42044002
6	Quick coupler Parker	HP	R134a	TX42044004
7	Quick coupler	LP	R134a	TX13.081
8	Quick coupler	HP	R134a	TX13.080
9	Renault adapter	HP-LP	R134a	TX13.095
10	Quick coupler BMW, Volvo, Ford, extended	HP	R134a	TX13.038D
11	Quick coupler BMW, Volvo, Ford, extended	HP	R1234yf	TX13.039
12	Quick coupler O-ring	HP	R134a	TX430002113
13	Quick coupler O-ring	LP	R134a	TX430002111

Adapters



1



2



3



4



5



6



7



8



9



10



11



12



13



14



14

 Description	Index
1 Adapter, extension HP/HP R134a	TX13.040
2 Adapter, extension LP/LP R134a	TX13.041
3 Adapter DuPont LP R1234yf	TX7950025800
4 Adapter Honeywell LP R1234yf	TX7950025810
5 Adapter DuPont HP R1234yf	TX7950026650
6 Adapter Honeywell HP R1234yf	TX7950026660
7 Adapter 1/4" x 1/4"	TX7950024040
8 Adapter 1/4" x R123yf	TX7950025780
9 Adapter 1/4" x 14x1,5	TX7950026285
10 Adapter M12x1,5 x M14x1,5	TX3903745
11 Adapter kit R134a	TX14.017
12 Adapter kit R1234yf, TEXA	TX3903475
13 Adapter nitrogen	TX14.013
14 Adapter hydrogen	TX14.014
15 Adapters LP + HP - R1234yf to R134a	TX14.012

Valves and tools



Description

Index

	Description	Index
1	Valve core removal	TX14.020
2	Valve core set, 100 pcs., 10 types	TX14.021
3	Valve core standard, 10 pcs.	TX8UW351283811
4	Valve core JRA, 5 pcs.	TX8UW351282971
5	Valve core Peugeot/Volvo, 10 pcs.	TX8UW351282991
6	Valve core GM, 10 pcs.	TX8UW351281921
7	Valve core Eaton 13mm, 5 pcs.	TX8UW351286911
8	Valve core Eaton 16mm, 5 pcs.	TX8UW351286921
9	Valve core VW, Mercedes, 1 pc.	TX7950024830
10	Valve core Renault, 1 pc.	TX7950025400
11	Valve core Kia, 1 pc.	TX7950025410
12	Valve core R1234yf, 21,8 x 8 mm, 1 pc.	TX7950026690
13	Valve core R1234yf, 22,1 x 9,9 mm, 1 pc.	TX7950026700
14	Valve core removal HP/LP R134a/R1234yf	TX14.019
15	Valve HP M12 x 1,5	TX8UW351248051
16	Valve HP M15 x 1	TX8UW351089001
17	Valve LP M13 x 1	TX8UW351089011
18	Valve LP M10 x 1,25	TX7950024800
19	Octagonal socket LP	TX98134
20	Octagonal socket HP	TX98234
21	Safety cap STD LP	TX795002424
22	Safety cap STD HP	TX795002425
23	Safety cap Japan LP	TX88.101
24	Safety cap Japan HP	TX88.102
25	Valves and caps kit	TX88.903
26	Orifice tubes kit	TX8UW351233831
27	AC wrenches kit	W-BGS2275

O-rings

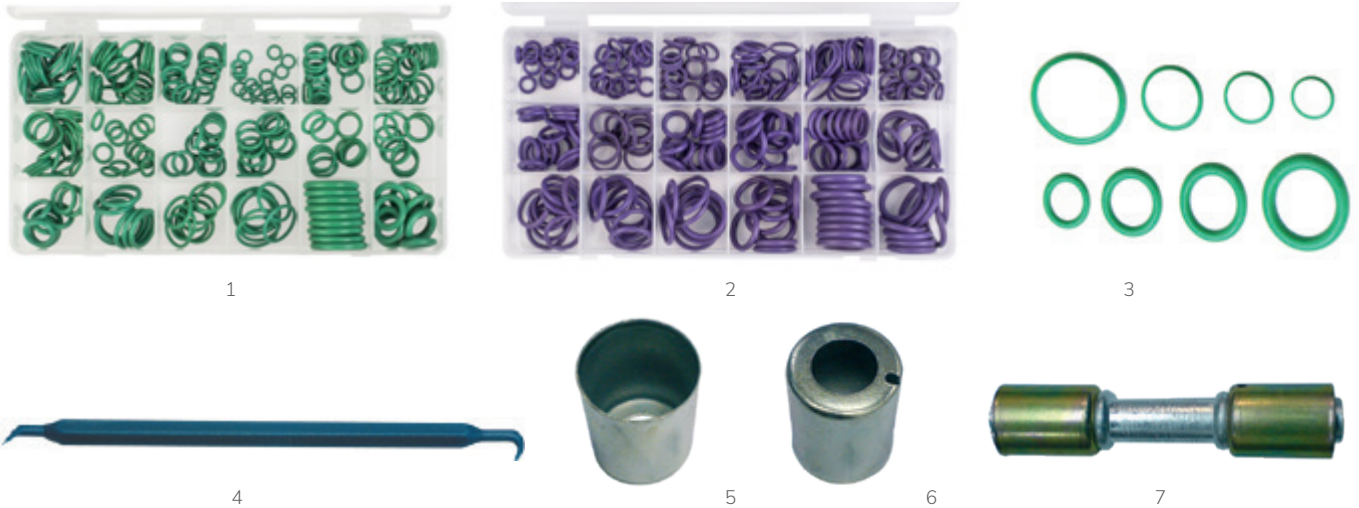

👁	Description	Index
1	O-ring kit, 265 pcs., 18 types	TX14.021
2	O-ring kit violet, 256 pcs., 18 types	TX7936210720
3	O-ring kit, 225 pcs., 8 types	W-BGS8121
4	O-ring remover	TX13.086
5	Sleeve beadlock STD no 8	TX060-003
	Sleeve beadlock STD no 10	TX060-004
	Sleeve beadlock STD no 12	TX060-005
6	Sleeve beadlock reduced hose size no 6	TX8FF351045801
	Sleeve beadlock reduced hose size no 8	TX8FF351045811
	Sleeve beadlock reduced hose size no 10	TX8FF351045821
	Sleeve beadlock reduced hose size no 12	TX8FF351045831
7	Nipple STD no 6	TX060-006
	Nipple STD no 8	TX060-007
	Nipple STD no 10	TX060-008
	Nipple STD no 12	TX060-009

Vacuum pump oils



👁	Description	Index
1	Vacuum pump oil TEXA, 450 ml	TX10100020
2	Vacuum pump oil, 1 L	TX90032-6

A/C station accessories



👁	Description	Index
1	Filter dryer – TEXA K600E	TX42801002
	Filter dryer – TEXA K700E	TX42801004
	Filter dryer – INVENTO ACix+, Advance	INVA07.500
2	O-ring – filter dryer TEXA	TX430008020
4	Mechanic filter – TEXA	TX74350208
5	Maintenance kit - INVENTO Handy Advance	INVACR103
6	POE bottle TEXA K760R, K780R	TX3903655
	PAG bottle TEXA K760R, K780R	TX3902460
	UV bottle TEXA K760R, K780R	TX3903340
	Drained oil bottle TEXA K760R, K780R	TX3904319
7	Calibration weight – TEXA K760R	TXPRUC1
8	Extension hoses 3m - TEXA	TX74350900
	Hose LP 6m – INVENTO	INVHA005
	Hose HP 6m – INVENTO	INVHA006
	Hose LP 2,5m – Magneti Marelli	TX7950013760
	Hose HP 2,5m – Magneti Marelli	TX7950013770
	Hose LP 3m – TEXA	TX42703002
	Hose HP 3m – TEXA	TX42703004
9	Printer paper 58xD32 -TEXA	TX81M00058
10	Cover – TEXA	TX3903241
	Cover – INVENTO Handy Advance	INVHA007

Tools



1



2



3



4



5



6



7



8

👁	Description	Index
1	Digital thermometer - probe	TX52229
2	Digital thermometer - infrared	W-BGS6005
3	Test and filtering kit	TX11.090
4	Flushing device Easy Flush	INVHA004
5	Flushing device with pulsation	TX14.002
6	Manual flushing kit	TX7950024750
	Flushing adapters - profi	TX14.003
7	Refrigerant database R134a, R1234yf	TX7935090895
8	SpringLock tools, kit	TXWT3002

Wheel aligners 3D



👁	Description	Autotracking	Engine cradle adjust	Locked toe	Small targets	3-point clamps	Turntables	Index
1	INVENTO XV 350						steel	INVXV350
2	INVENTO XV 450	✓	✓	✓			steel	INVXV450
3	INVENTO XV 550X	✓	✓	✓	✓	✓	aluminum	INVXV550X-SKP

Wheel aligners



1



2



3

👁️	Description	Technology	Application	Semi-trailers and trailers kit	Portable PC	Scale for buses	Double steering axle kit	Cabinet	Index
1	Axis 50	laser	agri					box	HA922000005
2	Axis 500	laser	truck					box	HA922000050
3	Axis 4000 Pro PREMIUM	3D	truck					mobile stand	HA924000010
	Axis 4000 Standard	3D	truck					mobile cabinet	HA924000030
	Axis 4000 Premium	3D	truck	✓	✓	✓	✓	mobile cabinet	HA924000050

Accessories



👁	Description	Index
1	Tyre removing kit, 2 pcs. – INVENTO XV	INVXV002
2	Brake holder	INVXV003
3	Steering wheel holder	INVXV004
4	Inclinometr MB - Haweka	HA913009024
5	Turntables 2pcs., 40 mm	INVSL007
6	Turntables 2 pcs., 50 mm with rubber spacers	INVXV011
	Rubber spacer, 1 pc.	INVXV018
7	Sliding plate, 1 pc. (470 x 400 x 50 mm)	W-UT-AK015
8	Ramps, 2 pcs. (1130 x 510 x 50 mm)	W-UT-AK010
9	Long clamps pin	INVXV013
10	Spirit level Haweka	JBPOZ
11	Spirit level	W-BGS9977
12	Mobile platform	MF8-3490008

Autel diagnostic tools



1



2



3



4



5



6

👁️	Description	Basic diagnostic (read and erase codes)	Full diagnostics (coding, adaptations)	ECU coding/programming	PASS-THRU	TPMS programming and diagnostic	IMMO (key)	Update	Display and memory	Index
1	Autel MaxiTPMS TS 608	✓	✗	✗	✗	✓	✗	1 year	7.0"/32 GB	AUTS608
2	Autel MaxiTPMS ITS600 PRO	✓	✗	✗	✗	✓	✗	1 year / TPMS lifetime	5.5"/64 GB	AUITS600
3	Autel DS808 BT / DS808 TS	✓	✓	✓	✗	✗ / ✓	✗	1 year	7.0"/32 GB	AUDS808BT / AUDS808TS
4	Autel MS 906 BT	✓	✓	✓	✗	✗	✗	1 year	8.0"/64 GB	AUMS906BT
5	Autel MS 908 S PRO	✓	✓	✓	✓	✗	✗	1 year	9.7"/64 GB	AUMS908SPRO
6	Autel IM 608	✓	✓	✓	✓	✗	✓	1 year	10.1"/64GB	AUIM608

Laser measurement of the tread of tyres



1

👁	Description	Laser measurement of the tread of tyres	Analysis of uneven wear of tyres	Pictures documentation of tyres	Raports	Display	Index
1	Autel TBE 200	✓	✓	✓	QR Code / via ITS 600	1,65"	AUTBE200

Digital inspection camera Autel MV105



1

👁	Description	Test tight and hard-to-reach places in the car	Recording movies	Measurement types	Raports	Display	Index
1	Autel MV105	✓	high-quality	camera	on computer (mini USB cable)	✗	AUMV105

PowerScan Auto Circuit Tester Autel PS100



1

👁	Description	Test for continuity with its built-in auxiliary ground lead	Test for poor ground contacts	Measurement	Raports	Display	Index
1	Autel PowerScan PS100	✓	✓	voltage current resistance	Diode and graph on the display	LCD	AUPS100

Auto Battery Tester Autel MaxiBAS BT608



1

👁	Description	Battery Diagnostics	Electrical System Analyzer Circuit Tester	Printer	Connectivity	Display	Index
1	Autel MaxiBAS BT608	✓	✓	voltage current resistance	Wi-Fi USB 2.0, Type C, BT5.0+EDR	5.5" LCD touch screen	AUBT608

Alloy Wheel Straightener



ECONOMY

1

👁	Description	Power	Diameter range	Pump pressure	Power supply	Index
1	INVENTO SW700 device for straightening rims + lathe 10-24"	1,3 kW	10" - 24"	140 bar	3 x 400V / 50 Hz	INVS700

Piston compressors



1



2



3



4



5



6

👁	Description		Capacity	Tank	Maximum pressure	Power	Index
1	INVENTO 320	ECONOMY	320 l/min.	100 l	10 bar	1,5 kW	INV28100320
	INVENTO 475	ECONOMY	475 l/min.	200 l	10 bar	3 kW	INV38200475
2	INVENTO 560B	ECONOMY	560 l/min.	270 l	10 bar	3 kW	INV49270560B
	INVENTO 830	ECONOMY	830 l/min.	270 l	10 bar	5,5 kW	INV60270830
3	INVENTO 1210	ECONOMY	1 210 l/min.	500 l	10 bar	7,5 kW	INV705001210
4	Gudepol HD 40		510 l/min.	200 l	10 bar	3 kW	GDHD40200
5	Gudepol HD 50		700 l/min.	270 l	10 bar	4 kW	GDHD50270
	Gudepol HD 75		900 l/min.	270 l	10 bar	5,5 kW	GDHD75270
6	Gudepol HD 100		1 200 l/min.	500 l	10 bar	7,5 kW	GDHD100500

Piston compressors



1



2

👁	Description		Capacity	Tank	Maximum pressure	Power	Index
1	INVENTO TV 580		580 l/min.	270 l	15 bar	4 kW	INVTV5027058015
2	Gudepol HDT 50		580 l/min.	270 l	15 bar	4 kW	GDT50270
	Gudepol HDT 100		1 150 l/min.	500 l	15 bar	7.5 kW	GDT100500

Screw compressors



👁	Description	Air dryer	Capacity	Tank	Maximum pressure	Power	Index
1	INVENTO HT 510 ECONOMY	✓	750 l/min.	270 l	10 bar	5,5 kW	INVHT510270VT
	INVENTO HT 710 ECONOMY	✓	900 l/min.	500 l	10 bar	7,5 kW	INVHT710500VT
2	INVENTO SHD 710	✓	900 l/min.	500 l	10 bar	7,5 kW	INVHD710500VT
	INVENTO SHD 1110	✓	1 500 l/min.	500 l	10 bar	11 kW	INVHD1110500VT
	AIRPOL KT7-10	✓	950 l/min.	500 l	10 bar	7,5 kW	FIAIRPOLKT7-10
	AIRPOL KT11-10	✓	1 450 l/min.	500 l	10 bar	11 kW	FIAIRPOLKT11-10
3	AIRPOL K7-10		950 l/min.	500 l	10 bar	7,5 kW	FIAIRPOLK7-10
	AIRPOL K11-10		1 450 l/min.	500 l	10 bar	11 kW	FIAIRPOLK11-10



👁	Description	Air dryer	Capacity	Tank	Maximum pressure	Power	Index
1	INVENTO SHD 713	✓	780 l/min.	500 l	13 bar	7,5 kW	INVHD713500VT
	INVENTO SHD 1113	✓	1 150 l/min.	500 l	13 bar	11 kW	INVHD1113500VT
2	AIRPOL KT7-13	✓	780 l/min.	500 l	13 bar	7,5 kW	FIAIRPOLKT7-13
	AIRPOL KT11-13	✓	1 166 l/min.	500 l	13 bar	11 kW	FIAIRPOLKT11-13
3	AIRPOL K7-13		780 l/min.	500 l	13 bar	7,5 kW	FIAIRPOLK7-13
	AIRPOL K11-13		1 166 l/min.	500 l	13 bar	11 kW	FIAIRPOLK11-13



Dryers



1

👁 Description	Flow rate	Working Pressure	Index
Dryer OPA 10	833 l/min.	16 bar	FIAIRPOLOP10**
Dryer OPA 20	1200 l/min.	16 bar	FIAIRPOLOP20**
1 Dryer OPA 30	1833 l/min.	16 bar	FIAIRPOLOP30**

Compressor oils



1



2



3

👁 Description	Capacity	Index
1 Piston compressor oil	1 l	PNOLEJS1**
2 Piston compressor oil	2 l	PNOLEJS2**
3 Screw compressor oil	5 l	PNOLEJS4**

** on request

Thermopress machines



👁	Description		Heating temp.	Control	Motor power	Index
1	Thermopress pneumatic INVENTO PV 150	ECONOMY	150 °C	manual	350 W	INV150
2	Thermopress pneumatic INVENTO PV 165C	ECONOMY	165 °C	electronic controller	350 W	INV165C
3	Thermopress Standard TIP-TOPOL	PREMIUM	160 °C	manual	540 W	TP517-0100
4	Thermopress Pneumatik TIP-TOPOL	PREMIUM	160 °C	manual	540 W	TP517-0110

Additional equipment for thermopress



👁	Description	Index
1	Support stand, floor-mounted	TP517-0030-UNI
2	Pneumatic support stand	TP517-0040-UNI
	Adapter to cure valves	TP517-0051
3	Rubber for the adapter	TP517-0052

Aluminum profiles for thermopress machines TIP-TOPOL



Designed for repairing damage to any zones of the tire while maintaining the correct shape. Aluminum profiles ensure good heat conductivity and steady temperature distribution at the repair site.



👁	Description	Size					Index
1	Sidewall pressure plate, suitable for low-section tyres and sidewall repairs	100 x 160 mm	✓				517-3334
2	Aluminum heating plate profile shape, flat suitable for tread (outside)	225 x 150 mm			✓	✓	517-3310
3	Tread pressure plate suitable for tread (inside)	200 x 130 mm		✓	✓	✓	517-3365
4	Sidewall pressure plate, suitable for sidewall repairs trucks, 80-series	130 x 208 mm		✓			517-3327
5	Pressure plate D inside suitable for truck tyre shoulder inside	195 x 103 x 35 mm		✓			517-3451
6	Pressure plate G inside suitable for truck tyre shoulder inside	195 x 103 x 38 mm		✓			517-3452
7	Pressure plate E outside suitable for truck tyre shoulder outside	180 x 120 x 39 mm		✓			517-3461
8	Pressure plate H outside suitable for truck tyre shoulder outside	180 x 120 x 35 mm		✓			517-3462
9	Aluminum heating plate profile shape, contour suitable for truck tyre tread (outside) and shoulder	230 x 150 mm		✓			517-3963
10	Aluminum heating plate profile shape, suitable for tyre tread (outside) and truck tyre shoulder	230 x 150 mm		✓			517-3970
11	Aluminum heating plate cover suitable for truck tyre shoulder	210 x 140 mm		✓			517-3987
12	Sidewall pressure plate 275/70 R 22.5 suitable for sidewall repairs trucks, 70-series	210 x 115 mm		✓			517-4003

Pressure pads



👁	Description	Size	Index
1	Pressure equalizing pad car, size 0	110 x 110 mm	517-3853
2	Pressure equalizing pad car, small	180 x 130 mm	517-2438
3	Pressure equalizing pad truck, large	210 x 150 mm	517-1989
4	Pressure equalizing pad tractor, long	260 x 100 mm	517-1965
5	Oval rubber cover truck	-	517-7165
6	Oval rubber cover car	-	517-7172

Accessories for thermopress machines TIP-TOPOL



👁	Description	Index
1	Spare heating plate 160 °C, 230 V	517-3570
	Spare heating plate Thermopress, without aluminum casing, STANDARD and PNEUMATIK (previous type)	517-3640
2	Lower heater holder, for Thermopress Standard and Pneumatic	TP517-0100-48 1
3	Ball joint thermocouple for Thermopress Standard	TP517-0100-86 1
4	Ball joint Thermocouple for Thermopress Pneumatic	TP517-0110-86 1

Aluminum profiles for thermopress machines INVENTO

Allows repair of damage to any part of the tyre and maintains its correct shape. Aluminum profiles ensure good heat conduction and uniform temperature distribution in the repair area.

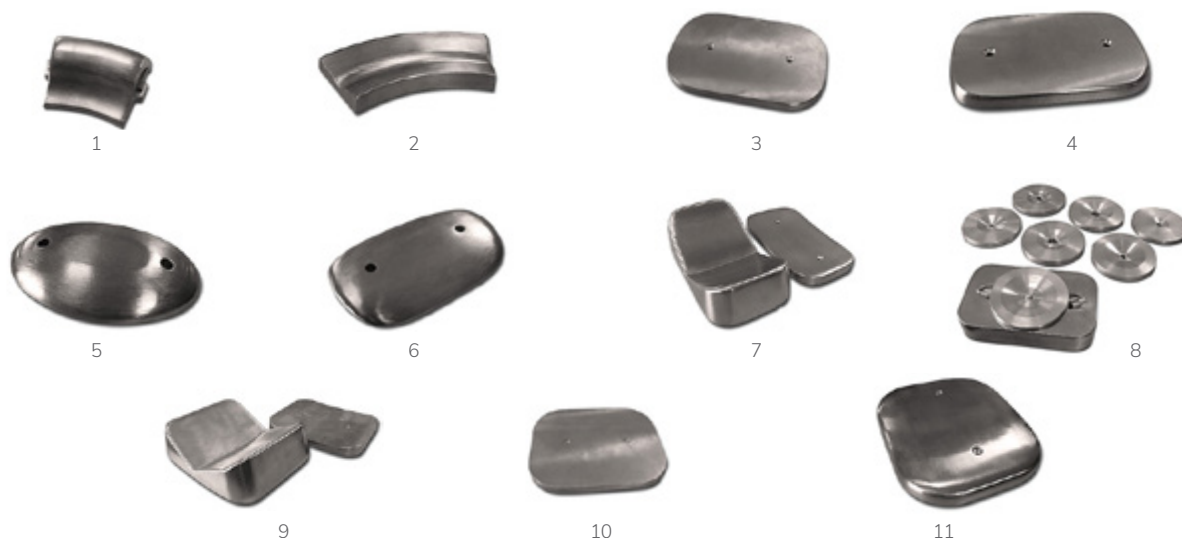

👁	Nazwa	Index
1	Profile for repairing the sidewall of low-profile tires	INVPV-101
2	Profile to repair bead toe edges	INVPV-102
3	Large, flat profile for tractors and heavy equipment	INVPV-103
4	Small flat profile - for tread repairs	INVPV-104
5	Universal elliptical profile	INVPV-105
6	Profile to repair: tire sidewall	INVPV-106
7	Set of matrices up to 22,5", 2 pcs	INVPV-107
8	Profile for the repair of air valves with seven inserts	INVPV-108
9	Set of matrices up to 23,5", 2 pcs	INVPV-109
10	Profile - for large repairs 250 x 200 mm flat	INVPV-110
11	Profile - for large repairs 200 x 180 mm	INVPV-111

Car tyre spreaders



👁	Description	Index
1	Car tyre spreader	595-2971
2	Car tyre spreader	AT-R1
3	Tyres and tubes tensioner	TP519-0003
4	Manual Car tyre spreader	CRW275MH
5	Pneumatic Car tyre spreader	CRW275SP

Truck tyre spreaders



👁	Description	Index
1	Pneumatic spreader for tires, manual	TP519-0050-UNI
2	Truck tyre pneumatic spreader	CRW528S
3	Truck tyre pneumatic spreader	AT000-R2**

** on request

Car Tyre test tank



1

👁	Description	Max. wheel diameter	Max. width of a wheel	Max. working pressure	Basket load capacity	Index
1	Tyre test tank - car	900 mm	300 mm	10 bar	70 kg	UNIW-A1

Wheel dollies



1



2

👁	Description	ECONOMY	Capacity	Max. wheels diameter	Max. number of wheels	Additional information	Index
1	Ahcon wheel trolley		120 kg	630 mm	4	a round trolley / stand allows for easy and ergonomic transport of 8 tires or 4 wheels	589-3584
2	Wheels trolley		200 kg	750 mm	6	large inflatable wheels ensure small resistance to movement on difficult surfaces and excellent shock absorption	CRW004

Truck wheel dollies



1



2



3

👁	Description	ECONOMY	Capacity	Max. wheels diameter	Additional information	Index
1	Wheel dolly for truck wheels	ECONOMY	127 kg	360 mm	outer diameter to 360 mm	CRW003-127
2	Wheel dolly for truck wheels	PREMIUM	150 kg	1 100 mm	outer diameter 600 mm - 1 100 mm	CRW003-150
3	Wheel dolly for truck wheels COMPAC WD Mobile		250 kg	1 120 mm	max. wheel size 445/65 22,5", outer diameter to 1 120 mm	CO-WDMobile

Compac wheel dollies



1



2



👁	Description		Capacity	Max. wheels diameter	Application	Additional information	Index
1	Wheel dolly for trucks and buses, with sliding arms	PREMIUM	500 kg	1 360 mm	truck, buses	diameter from Ø 260 mm to 1 320 mm	CO-WD500
3	Wheel dolly for agricultural and earth moving machinery, with rollers adjustable to wheel width	PREMIUM	1 600 kg	1 120 mm	agricultural vehicles	diameter from Ø 1 150 mm to 2 150 mm, 1 050 mm in width mm in depth	CO-WD1600

TIP-TOPOL Sp. z o.o.

Kostrzynska 33
62-010 Pobiedziska, Poland
export@tiptopol.pl
M. +48 887 817 116

Workshop Equipment

M. +48 512 417 640

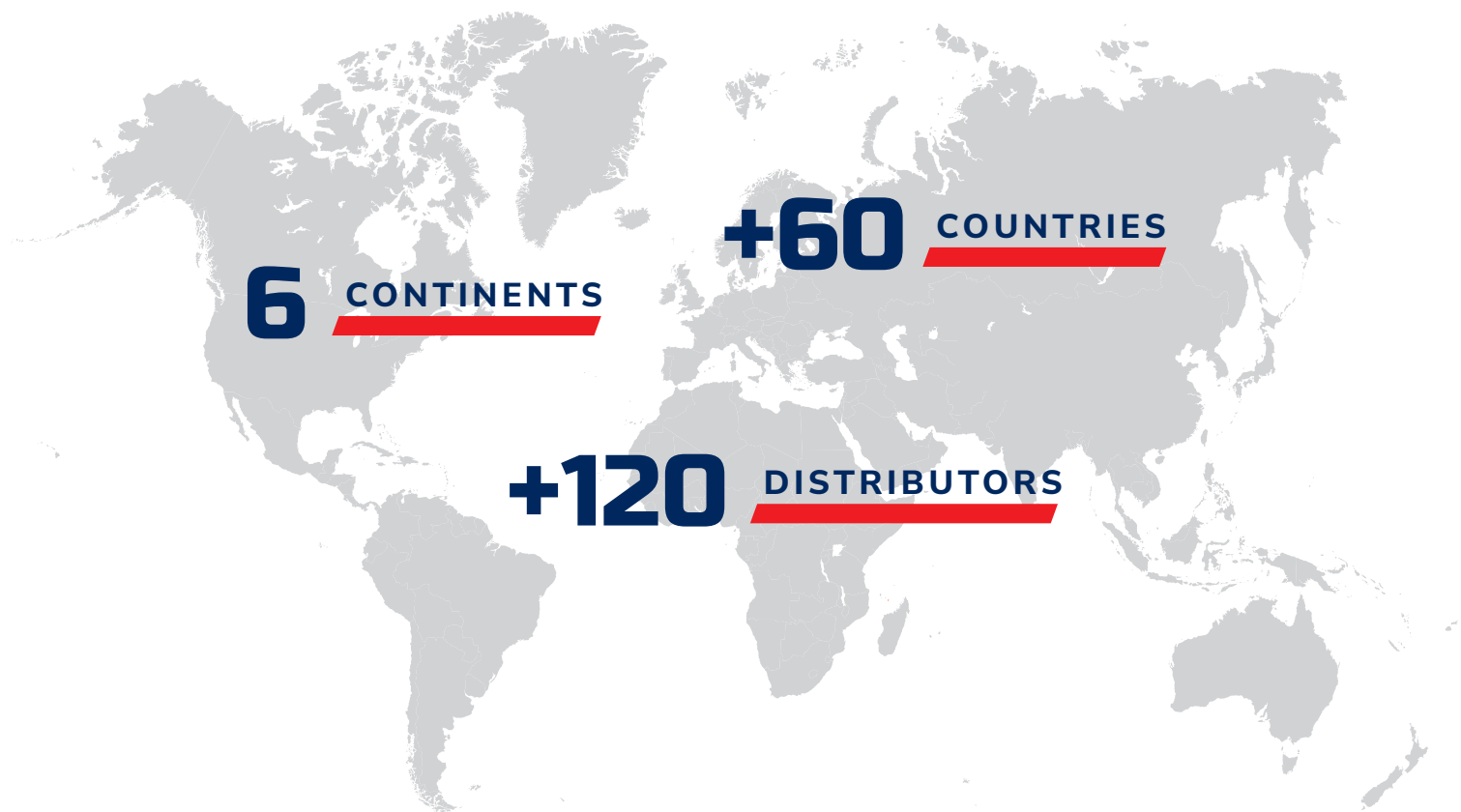

Be Online with shop.tiptopol.eu

You can use B2B platform to:

- Find all our products with photos, descriptions and technical data
- Check current prices
- See the level of our products stock
- Check delivery times for unavailable products
- Place an order

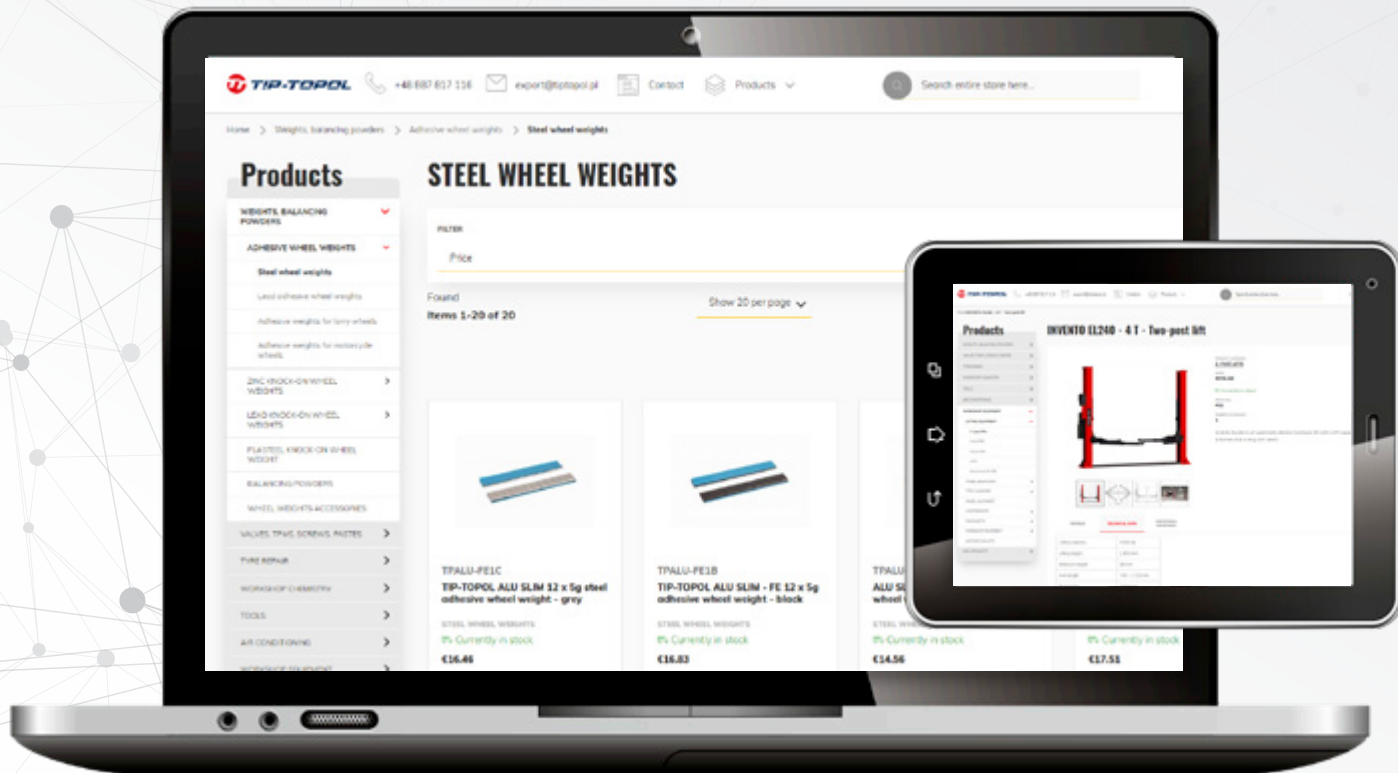

From anywhere, at any time!



NEOTEC INVENTO  Hercules

Headquartes: Kostrzynska 33, 62-010 Pobiedziska

Production: Polska Wies 15, 62-010 Pobiedziska